



The World's Favorite Shade



20
25

INTRODUCTION

For 41 years, Treasure Garden has manufactured the widest selection of shade products in the industry. We offer more than 25,000 variations of shade solutions and accessories. From our state-of-the-art cantilevers to our wide variety of fashion forward market umbrellas, Treasure Garden has a perfect shade solution for your outdoor environment.

Treasure Garden is a one stop shop for our customers. We offer the most comprehensive lines of umbrellas, bases, lights, protective covers, cleaning and maintenance products and outdoor rugs in the industry. Our Shademaker and Jardinico collections offer elegantly designed parasols with robust construction built to last for commercial or residential applications; all from one reliable source.

Our Southern California facility in Baldwin Park, as well as both our state-of-the-art facilities in Ningbo and Qingdao, China, are integral parts of our business operation and point of service. Treasure Garden is a vertically integrated manufacturer. We manufacture and produce over 90% of the components used in our products from their raw state. This allows Treasure Garden the advantage of monitoring every stage of the manufacturing process to maintain a consistent level of quality and delivery.

The 6,000 employees who share in the same vision on a daily basis and their attention to detail enables Treasure Garden to continue to be...

“The World’s Favorite Shade”.





p.002

TREASURE GARDEN.
The World's Favorite Shade

p.092

SHADEMAKER
architectural shade

p.124

jardinico®
CARACTÈRE

TABLE OF CONTENTS

AKZ PLUS CANTILEVER

13' Starlux AKZ Plus	6
 10'x13' Starlux AKZ Plus	7
13' AKZ Plus	8
10'x13' AKZ Plus	9
11.5' AKZ Plus	10
11' AKZ Plus	11

AG CANTILEVER

11.5' AG25T	14
10' AG25TSQ	15
10' AG19A	16

CANTILEVER BASES

Bases and Mount Kit Options	18-19
-----------------------------	-------

SPECIALTY

10' Shanghai Collar Tilt	22
--------------------------	----

MARKET

11' TWIST <i>tilt</i>	26
9' TWIST <i>tilt</i>	27
9' Starlux Collar Tilt	28
11' Collar Tilt	29
9' Collar Tilt	30
 11' FLEX	30A
 9' FLEX	30B
 7.5' FLEX	30C
11' Auto Tilt	31
9' Auto Tilt	32
8'x10' Auto Tilt	33
9' Glide Tilt	34
7.5' Glide Tilt	35
9' Push Button Tilt	36
7.5' Push Button Tilt	37
9' Quad Pulley Lift	38

FABRIC

Fabrics	42-45
Fabric Index	46-47
Fabric Cleaning and Maintenance Instructions	48

ACCESSORIES

Market Bases and Mount Kit Options	52-57
Umbrella Lights	60-61
 Outdoor Rugs	64-68

TG CARE

 Protective Furniture Covers	74-77
Care and Maintenance Products	78-79

MERCHANDISING

Designer Canopy Collection	82-83
Rug and Umbrella Displays	84-85
Science Behind Shade	86-87

SALES PROGRAMS

TG Custom - Domestic	88
TG Direct - Container	89
TGEx Quick-Ship	90
Cantilever Quick-Ship	91

PRODUCT INFORMATION

Terms & Conditions	140-142
Warranty/Guarantee	143





TREASURE
GARDEN[®]

The World's Favorite Shade



CANTILEVER | AKZ COLLECTION

13' Starlux AKZ Plus Cantilever
Octagon Series

 10'x13' Starlux AKZ Plus Cantilever
Rectangle Series

13' AKZ Plus Cantilever
Octagon Series

10'x13' AKZ Plus Cantilever
Rectangle Series

11.5' AKZ Plus Cantilever
Square Series

11' AKZ Plus Cantilever
Octagon Series

SHOWN
Umbrella:
 AKZPRTLX-09
40433 Cast Silver





13' STARLUX AKZ PLUS

Cantilever Collection



129
sq ft. coverage



AVAILABLE IN



AKZP13LX-00D
Bronze



AKZP13LX-09D
Black



+ OPTIONAL ACCESSORY

Starlux AKZ Plus
Rechargeable Battery Pack
P-AKZPBATTERY-0_

SHOWN

Item No: AKZP13LX-09D w/ P-AKZPBATTERY-09 (Battery sold separately)
Fabric: 5439 Navy
Base: BASE-13-09 (Base sold separately)

ITEM NO.	AKZP13LX	
Size	13'	
Shape	Octagon	
Ribs	8	
Pole Diameter	3.64" x 2.56"	
Vent	DWV	
Lift	Crank	
Tilt	Front to Back	Left to Right
Weight	DWV 108 lbs.	DWV-V 109 lbs.
Cube	12	
Minimum Base Weight	400 lbs.	

SPECIFICATIONS

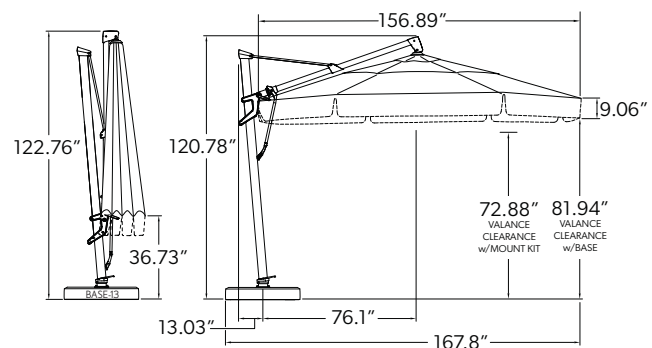

FEATURES

- Light strips built into (8) ribs for elegant and modern look
- (2) Light settings (low/high)
- Color temperature: 4000-4500K
- 20,000 Lifetime hours
- Powder coated aluminum
- 100% Kevlar mesh lift cord for added strength and durability
- Foot pedal to easily rotate umbrella 360°
- Infinite front to back tilt: Up to 40° back tilt
- Tilts left and right at: 18°, 36°, and 54° angles
- Built-in light adapter to fit Treasure Garden lights
- UL approved 33 ft. power supply cord
- Includes protective cover

+ OPTIONS

- Rechargeable battery pack (up to 8 hours of battery life)
- Designer canopy (page 82)
- Valance (add "V" to item no.) - Example: AKZP13LX-00DV
- Bases and mount kits (pages 18 & 19)

+ REPLACEMENT PARTS

Frame	AKZP13LX-0_
Canopy (DWV)	C813RD
Canopy (DWV with valance)	C813RDV
Protective cover	PFC920

Shipping Information: Truck Only

130
sq. ft. coverage



NEW 10'x13' STARLUX AKZ PLUS

Cantilever Collection



AVAILABLE IN



AKZPRTLX-00
Bronze



AKZPRLX-09
Black

+ OPTIONAL ACCESSORY

Starlux AKZ Plus
Rechargeable Battery Pack
P-AKZPBATTERY-0_



SHOWN

Item No: AKZPRTLX-09  w/ P-AKZPBATTERY-09 (Battery sold separately)
Fabric: 40434 Cast Slate
Base: BASE-13RA-09 (Base sold separately)

ITEM NO. AKZPRTLX

Size	10'x13'
Shape	Rectangle
Ribs	8
Pole Diameter	3.64" x 2.56"
Vent	SWV
Lift	Crank
Tilt	Front to Back Left to Right
Weight	108 lbs.
Cube	10.91
Minimum Base Weight	400 lbs.

FEATURES

- Light strips built into (8) ribs for elegant and modern look
- (2) Light settings (low/high)
- Color temperature: 4000-4500K
- 20,000 Lifetime hours
- Powder coated aluminum
- 100% Kevlar mesh lift cord for added strength and durability
- Foot pedal to easily rotate umbrella 360°
- Infinite front to back tilt: Up to 40° back tilt
- Tilts left and right at: 18°, 36°, and 54° angles
- Built-in light adapter to fit Treasure Garden lights
- UL approved 33 ft. power supply cord
- Includes protective cover

STRIPED FABRICS NOT AVAILABLE ON THIS STYLE.

SPECIFICATIONS

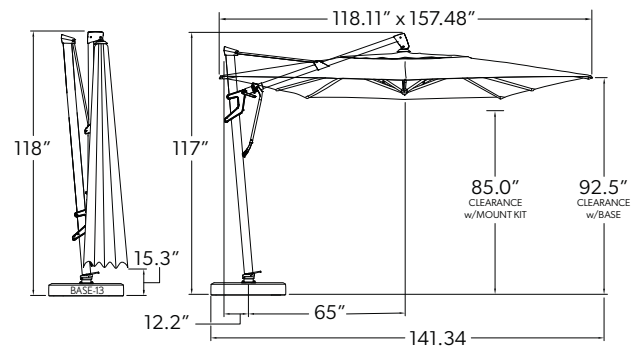

+ OPTIONS

- Rechargeable battery pack (up to 8 hours of battery life)
- Bases and mount kits (pages 18 & 19)

+ REPLACEMENT PARTS

Frame	AKZPRTLX-0_
Canopy (SWV)	CAKZRT
Protective cover	PFC920

Shipping Information: Truck Only

13' AKZ PLUS





Cantilever Collection



129
sq. ft. coverage



AVAILABLE IN

-  AKZP13-SSD
Silver Shadow,
Anodized
-  **NEW** AKZP13-WOD
Weathered Oak
-  AKZP13-00D
Bronze
-  AKZP13-02D
Anthracite
-  AKZP13-09D
Black

SHOWN

Item No: AKZP13-02D
Fabric: DC11 Style - 54048 Charcoal / 6670 Reliant Coast Stripe
Base: BASE-13RA-02 (Base sold separately)

ITEM NO.	AKZP13	
Size	13'	
Shape	Octagon	
Ribs	8	
Pole Diameter	3.64" x 2.56"	
Vent	DWV	
Lift	Crank	
Tilt	Front to Back	Left to Right
Weight	DWV 104 lbs.	DWV-V 105 lbs.
Cube	11.52	
Minimum Base Weight	400 lbs.	

SPECIFICATIONS

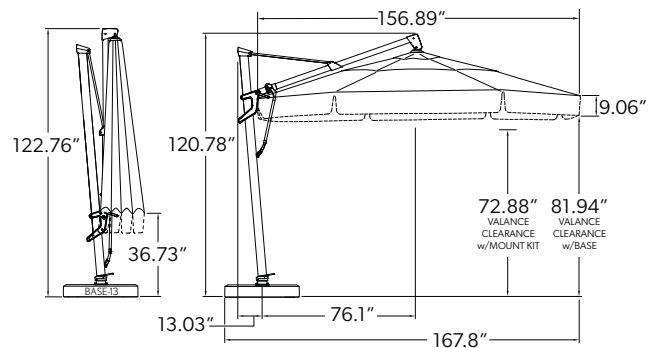

FEATURES

- Powder coated aluminum
- 100% Kevlar mesh lift cord for added strength and durability
- Foot pedal to easily rotate umbrella 360°
- Infinite front to back tilt: Up to 40° back tilt
- Tilts left and right at: 18°, 36°, and 54° angles
- Built-in light adapter to fit Treasure Garden lights
- Includes protective cover

+ OPTIONS

- Designer canopy (page 82)
- Valance (add "V" to item no.) - Example: AKZP13-00DV
- Bases and mount kits (pages 18 & 19)





+ REPLACEMENT PARTS

Frame	AKZP13-0_
Canopy (DWV)	C813RD
Canopy (DWV with valance)	C813RDV
Protective cover	PFC920

Shipping Information: Truck Only



AVAILABLE IN

-  AKZPRT-SS
Silver Shadow,
Anodized
-  **NEW** AKZPRT-WO
Weathered Oak
-  AKZPRT-00
Bronze
-  AKZPRT-02
Anthracite
-  AKZPRT-09
Black

SHOWN

Item No: AKZPRT-SS
Fabric: 5413 Spa
Base: BASE-13RA-02 (Base sold separately)

ITEM NO. AKZPRT

Size	10'x13'	
Shape	Rectangle	
Ribs	8	
Pole Diameter	3.64" x 2.56"	
Vent	SWV	
Lift	Crank	
Tilt	Front to Back	Left to Right
Weight	104 lbs.	
Cube	10.91	
Minimum Base Weight	400 lbs.	

FEATURES

- Powder coated aluminum
- 100% Kevlar mesh lift cord for added strength and durability
- Foot pedal to easily rotate umbrella 360°
- Infinite front to back tilt: Up to 40° back tilt
- Tilts left and right at: 18°, 36°, and 54° angles
- Built-in light adapter to fit Treasure Garden lights
- Includes protective cover

SPECIFICATIONS

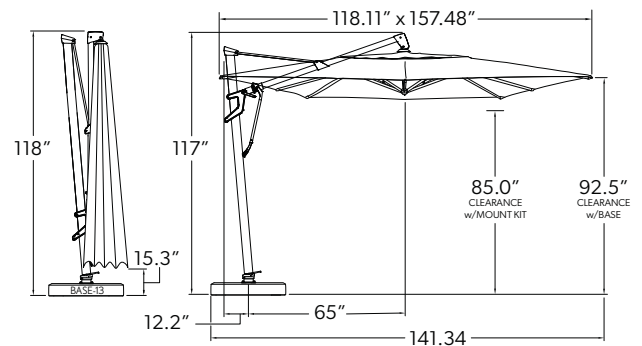

+ OPTIONS

- Bases and mount kits (pages 18 & 19)

+ REPLACEMENT PARTS

Frame	AKZPRT-0_
Canopy (SWV)	CAKZRT
Protective cover	PFC920

STRIPED FABRICS NOT AVAILABLE ON THIS STYLE.

Shipping Information: Truck Only

11.5' AKZ PLUS

Cantilever Collection



132
sq. ft. coverage



AVAILABLE IN



AKZPSQ11-00
Bronze



AKZPSQ11-09
Black

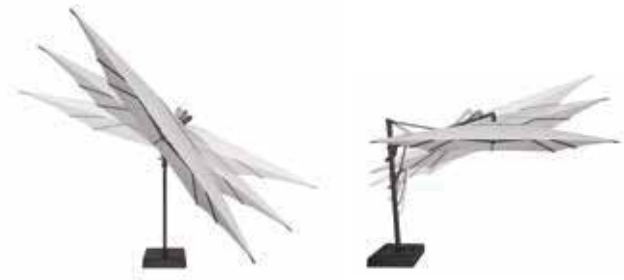

SHOWN

Item No: AKZPSQ11-09
Fabric: 57012 Cloud
Base: BASE-13RA-09 (Base sold separately)

ITEM NO.	AKZPSQ11	
Size	11.5'	
Shape	Square	
Ribs	8	
Pole Diameter	3.64" x 2.56"	
Vent	SWV	
Lift	Crank	
Tilt	Front to Back	Left to Right
Weight	SWV 89 lbs.	SWV-V 90 lbs.
Cube	12	
Minimum Base Weight	400 lbs.	

SPECIFICATIONS

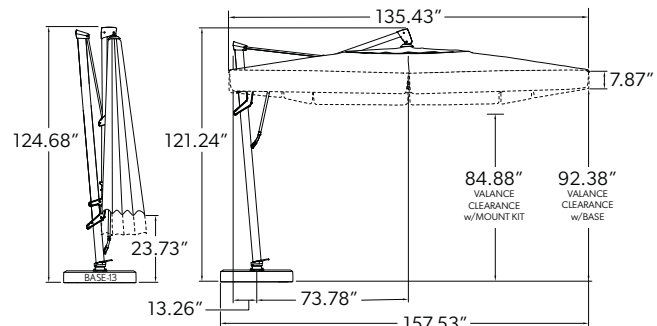

FEATURES

- Powder coated aluminum
- 100% Kevlar mesh lift cord for added strength and durability
- Foot pedal to easily rotate umbrella 360°
- Infinite front to back tilt: Up to 40° back tilt
- Tilts left and right at: 18°, 36°, and 54° angles
- Built-in light adapter to fit Treasure Garden lights
- Includes protective cover

+ OPTIONS

- Valance (add "V" to item no.) - Example: AKZPSQ11-00V
- Bases and mount kits (pages 18 & 19)

+ REPLACEMENT PARTS

Frame	AKZPSQ11-0_
Canopy (SWV)	C812SQ
Canopy (SWV with valance)	C812SQV
Protective cover	PFC920

Shipping Information: Truck Only



AVAILABLE IN

-  AKZP-00D
Bronze
-  AKZP-02D
Anthracite
-  AKZP-09D
Black



SHOWN

Item No: AKZP-00D
Fabric: DC11 Style - 40428 Cast Ash / 40599-01 Directional Linen Stripe
Base: BASE-AKZ-00 (Base sold separately)

ITEM NO.	AKZP	
Size	11'	
Shape	Octagon	
Ribs	8	
Pole Diameter	3.64" x 2.56"	
Vent	DWV	
Lift	Crank	
Tilt	Front to Back	Left to Right
Weight	DWV 99 lbs.	DWV-V 100 lbs.
Cube	10.91	
Minimum Base Weight	200 lbs.	

SPECIFICATIONS

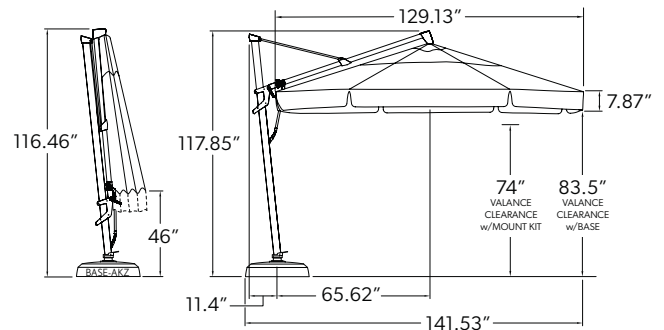

FEATURES

- Powder coated aluminum
- 100% Kevlar mesh lift cord for added strength and durability
- Foot pedal to easily rotate umbrella 360°
- Infinite front to back tilt: Up to 40° back tilt
- Tilts left and right at: 18°, 36°, and 54° angles
- Built-in light adapter to fit Treasure Garden lights
- Includes protective cover

+ OPTIONS

- Designer canopy (page 82)
- Valance (add "V" to item no.) - Example: AKZP-00DV
- Bases and mount kits (pages 18 & 19)

+ REPLACEMENT PARTS

Frame	AKZP-0_
Canopy (DWV)	C811RD
Canopy (DWV with valance)	C811RDV
Protective cover	PFC920

Shipping Information: Truck Only

CANTILEVER | AG COLLECTION

11.5' AG25T Cantilever
Octagon Series

10' AG25TSQ Cantilever
Square Series

10' AG19A Cantilever
Octagon Series

SHOWN
Umbrella:
AG25TR-00D
5422 Antique Beige

Base:
BASE-13RA-00

Rug:
Paradise Cove - Spa
RP-004-470-80 (7'10" x 10')





11.5' AG25T

Cantilever Collection



96
sq. ft. coverage



AVAILABLE IN



AG25TR-00D
Bronze



AG25TR-09D
Black



SHOWN

Item No: AG25TR-09D
Fabric: 40456 Cast Lagoon
Base: BASE-AKZ-09 (Base sold separately)

ITEM NO.	AG25TR	
Size	11.5'	
Shape	Octagon	
Ribs	8	
Pole Diameter	3.54" x 2.56"	
Vent	DWV	
Lift	Crank	
Tilt	Front to Back	Left to Right
Weight	DWV 72 lbs.	DWV-V 73 lbs.
Cube	6.8	
Minimum Base Weight	200 lbs.	

SPECIFICATIONS

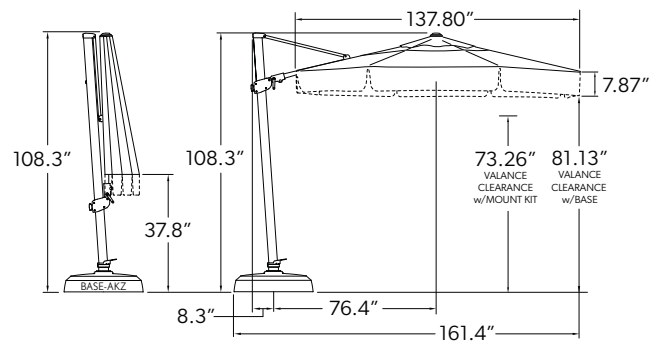

FEATURES

- Powder coated aluminum
- Foot pedal to easily rotate umbrella 360°
- Infinite front to back tilt: Up to 30° back tilt
- Infinite left to right tilting capabilities
- Built-in light adapter to fit Treasure Garden lights
- Includes protective cover

+ OPTIONS

- Valance (add "V" to item no.) - Example: AG25TR-00DV
- Bases and mount kits (pages 18 & 19)

+ REPLACEMENT PARTS

Frame	AG25TR-0_
Canopy (DWV)	CAG25RD
Canopy (DWV with valance)	CAG25RDV
Protective cover	PFC955

Shipping Information: Truck Only

100
sq. ft. coverage



10' AG25TSQ

Cantilever Collection



AVAILABLE IN



AG25TSQR-00
Bronze



AG25TSQR-09
Black



SHOWN

Item No: AG25TSQR-09
Fabric: 7865 New Block Sea Stripe
Base: BASE-AKZ-09 (Base sold separately)

ITEM NO.	AG25TSQR	
Size	10'	
Shape	Square	
Ribs	8	
Pole Diameter	3.54" x 2.56"	
Vent	SWV	
Lift	Crank	
Tilt	Front to Back	Left to Right
Weight	SWV 72 lbs.	SWV-V 73 lbs.
Cube	6.8	
Minimum Base Weight	200 lbs.	

SPECIFICATIONS

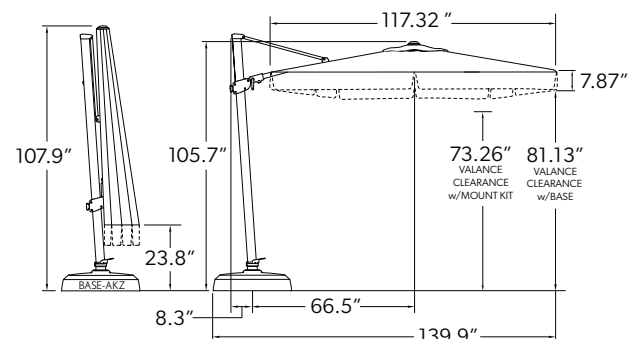

FEATURES

- Powder coated aluminum
- Foot pedal to easily rotate umbrella 360°
- Infinite front to back tilt: Up to 30° back tilt
- Infinite left to right tilting capabilities
- Built-in light adapter to fit Treasure Garden lights
- Includes protective cover

+ OPTIONS

- Valance (add "V" to item no.) - Example: AG25TSQR-00DV
- Bases and mount kits (pages 18 & 19)

+ REPLACEMENT PARTS

Frame	AG25TSQR-0_
Canopy (SWV)	CAG25TSQR
Canopy (SWV with valance)	CAG25TSQRV
Protective cover	PFC955

Shipping Information: **Truck Only**

10' AG19A



Cantilever Collection



70
sq. ft. coverage



AVAILABLE IN

-  AG19A-00
Bronze
-  AG19A-09
Black



SHOWN

Item No: AG19A-00
Fabric: 4822 Khaki
Base: BF10-00 Resin Base Weights (Base sold separately)

ITEM NO.	AG19A
Size	10'
Shape	Octagon
Ribs	8
Pole Diameter	2.17"
Vent	SWV
Lift	Crank
Tilt	Left to Right
Weight	60 lbs.
Cube	8.52
Minimum Base Weight	180 lbs.

SPECIFICATIONS

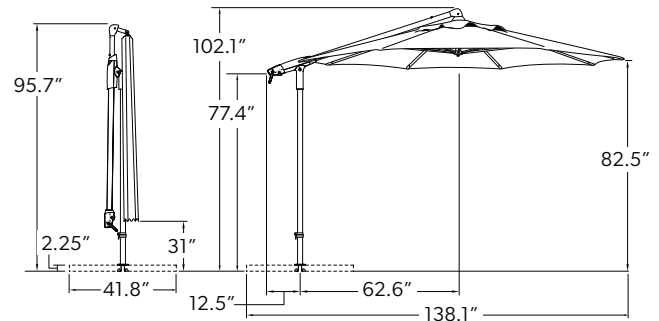

FEATURES

- Powder coated aluminum
- A full 360° rotation with base stem clamp
- Infinite left to right tilting capabilities
- AG universal cross bar stand (included) adjusts to fit 16" to 20" paver sizes
- Built-in light adapter to fit Treasure Garden lights

+ OPTIONS

- Base weights - BF10 (page 18)
- Protective cover - PFC912

+ REPLACEMENT PARTS

Frame	AG19A-0_
Canopy (SWV)	CAG19A

Shipping Information: Truck Only



SHOWN
Umbrella:
AG19A-00
5404 Natural

Base:
BF10-00

BASE OPTIONS

Cantilever Collection



AKZ13 Rolling Base | BASE-13RA-__

Includes: Steel base frame, resin lid, foot pedal, (4) wheels and (4) add-on weights to be filled with 300 lbs. of sand and water (sand not included).

Finishes	Size	Weight	Cube
00-Bronze 02-Anthracite 09-Black SD-Sand	34" x 34" x 7.5"	152 lbs.	11



Compatible with:
AKZP13LX,
AKZPRTLX, AKZP13,
AKZPRT, AKZPSQ11,
AKZP, AG25T,
AG25TSQ

AKZ13 Base | BASE-13-__

Includes: Steel base frame, resin lid, foot pedal, and four (4) add-on weights. Base holds up to 400 lbs. of sand (sand not included).

Finishes	Size	Weight	Cube
00-Bronze 02-Anthracite 09-Black SD-Sand	34" x 34" x 7.5"	74 lbs.	7



Compatible with:
AKZP13LX,
AKZPRTLX, AKZP13,
AKZPRT, AKZPSQ11,
AKZP, AG25T,
AG25TSQ

AKZ Base | BASE-AKZ-__

Includes: Resin base shell and lid. Base holds up to 200 lbs. of sand (sand not included).

Finishes	Size	Weight	Cube
00-Bronze 02-Anthracite 09-Black	32" x 32" x 7.5"	38 lbs.	5.5



Compatible with:
AKZP
AG25T
AG25TSQ

Resin Base Weights | BF10-__

Includes: Four (4) sections that fit onto the AG Universal Cross Bar Stand (included w/frame). Base weights hold up to 220 lbs. of sand (sand not included).

Finishes	Size	Weight	Cube
00-Bronze 09-Black	39.4" x 39.4" x 4.5"	29 lbs.	4.7



Compatible with:
AG19A

Our Mount Kit options open up a world of opportunities for large shades. Kits can be mounted 3 ways – Concrete, In-Ground and Wood Decks.

Compatible with: AKZP13LX, AKZPRTLX, AKZP13, AKZPRT, AKZPSQ11, AKZP, AG25T, & AG25TSQ

(MOUNT KITS REDUCES THE CANOPY CLEARANCE BY 7.5")



Concrete Mount
Includes:
Adapter plate and expansion bolts



In-Ground Mount
Includes:
Adapter plate, in-ground fitting,
and stem bolts



Wood Mount
Includes:
Adapter plate, base plate,
and countersunk bolts

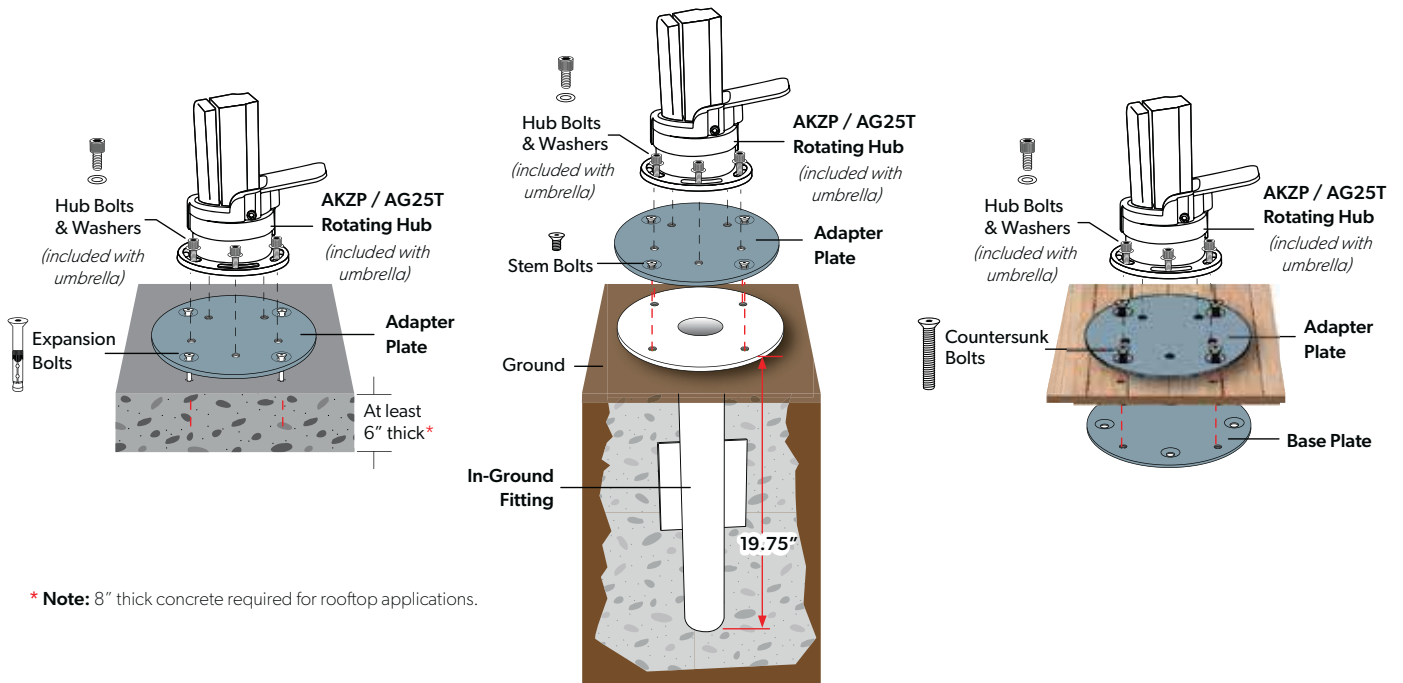

Mount Kits		Diameter	Overall Depth	Weight	Cube	Case Pack	Case Weight	Case Cube
Concrete Mount Kit	AMK-C22	8.5"	n/a	10 lbs.	0.22	6	58 lbs.	1.1
In-Ground Mount Kit	AMK-G	8.5"	19.75"	22 lbs.	1.51	4	81 lbs.	6.03
Wood Mount Kit	AMK-W	8.5"	n/a	14 lbs.	0.22	5	71 lbs.	1.1

Note: Can be ordered individually or case pack.

SPECIALTY COLLECTION

10' Shanghai Collar Tilt
Round Series

SHOWN
Umbrella:
USA45-09
5407 Henna

Base:
BG509/BW30





10' SHANGHAI COLLAR TILT

Specialty Collection



70
sq. ft. coverage



AVAILABLE IN



USA45-09
Black



SHOWN

Item No: USA45-09
Fabric: 6906 Arbor Smoke
Base: BKM1009 (Base sold separately)

ITEM NO.	USA45-09
Size	10'
Shape	Round
Ribs	24
Pole Diameter	1.5"
Bottom Pole	32"
Lift	Crank
Tilt	Collar
Weight	25 lbs.
Cube	2
Minimum Base Weight	80 lbs.

SPECIFICATIONS

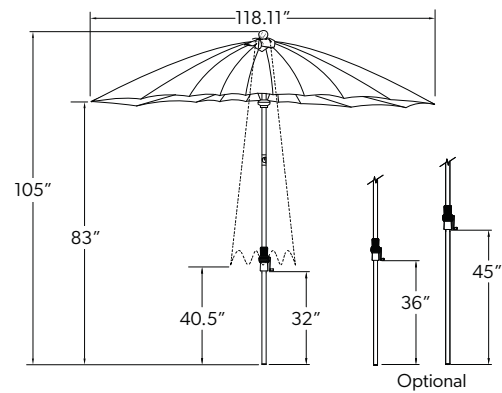

FEATURES

- 24 fiberglass ribs
- Powder coated aluminum
- Easy to twist collar tilt function
- Maximum tilt 30°
- Textured two-piece ribbed pole
- Crank lift system
- Fabric wrapped finial

+ OPTIONS

- Bases and mount kits (pages 52-55, 57)
- Protective cover - PFC902

+ REPLACEMENT PARTS

Frame	USA45-09
32" Bottom Pole (Standard)	BP32-8009
36" Bottom Pole	BP36-8019
45" Bottom Pole	BP45-8009

STRIPED FABRICS NOT AVAILABLE ON THIS STYLE.

Shipping Information: Standard Parcel/Courier Services



SHOWN

Umbrella:
USA45-09
6907 Lagoon Dove

Base:
BG509/BW30

Rug:
Illusion - Black Mirage
RP-505-360-80 (7'10" x 10')

MARKET COLLECTION

11' TWIST *tilt*
Octagon Series

9' TWIST *tilt*
Octagon Series

9' Starlux Collar Tilt
Octagon Series

11' Collar Tilt
Octagon Series

9' Collar Tilt
Octagon Series

 11' FLEX
Octagon Series

 9' FLEX
Octagon Series

 7.5' FLEX
Square Series

11' Auto Tilt
Octagon Series

9' Auto Tilt
Octagon Series

8'x10' Auto Tilt
Rectangle Series

9' Glide Tilt
Octagon Series

7.5' Glide Tilt
Octagon Series

9' Push Button Tilt
Octagon Series

7.5' Push Button Tilt
Octagon Series

9' Quad Pulley Lift
Octagon Series

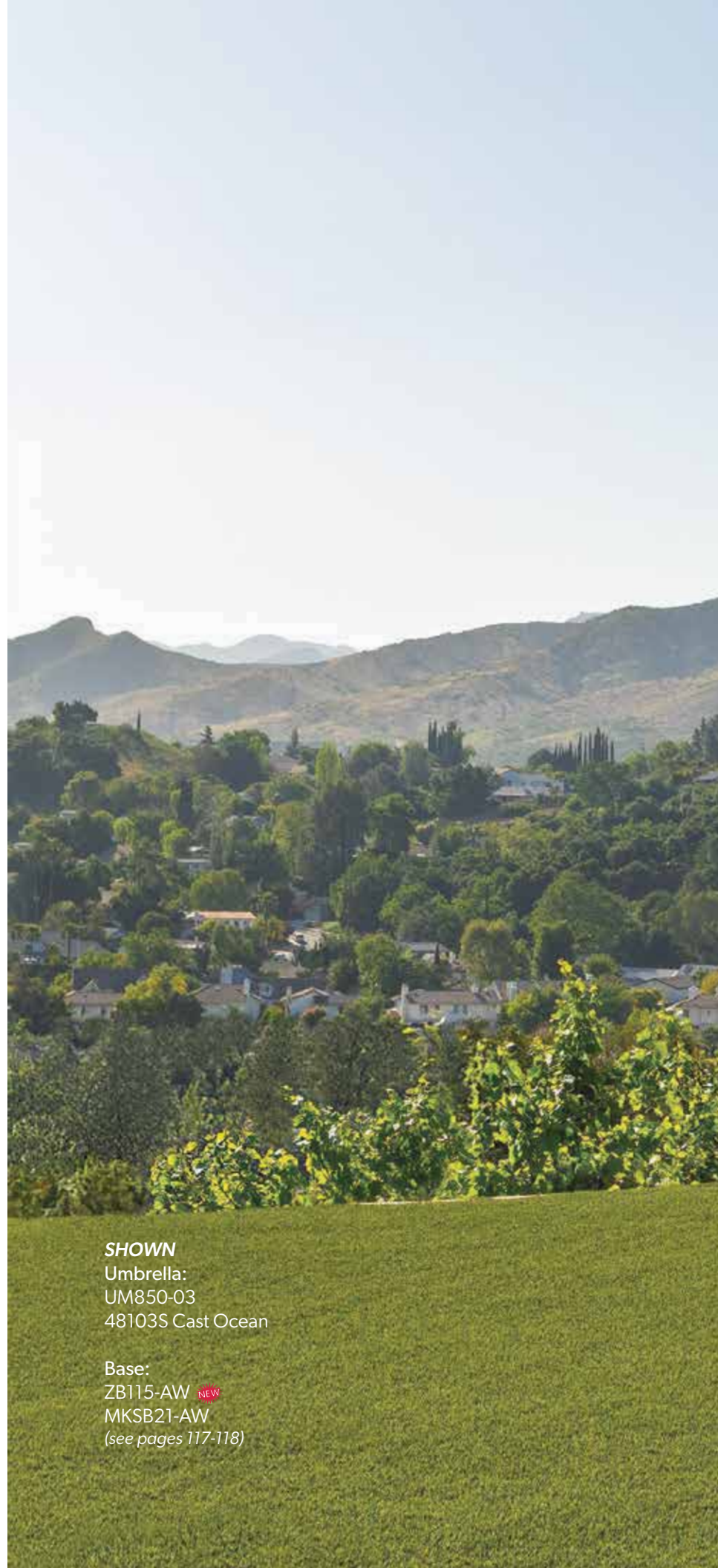

SHOWN

Umbrella:
UM850-03
48103S Cast Ocean

Base:
ZB115-AW 
MKSB21-AW
(see pages 117-118)





AVAILABLE IN

-  **UM851-02**
Anthracite
-  **UM851-03**
White

SHOWN

Item No: UM851-02
Fabric: 14087 Gateway Coast Stripe
Base: BG502 (Base sold separately)

ITEM NO.	UM851
Size	11'
Shape	Octagon
Ribs	8
Pole Diameter	1.58"/40mm
Bottom Pole	37"
Vent	SWV
Lift	Crank
Tilt	Collar
Weight	19 lbs.
Cube	4.41
Minimum Base Weight	80 lbs.

SPECIFICATIONS

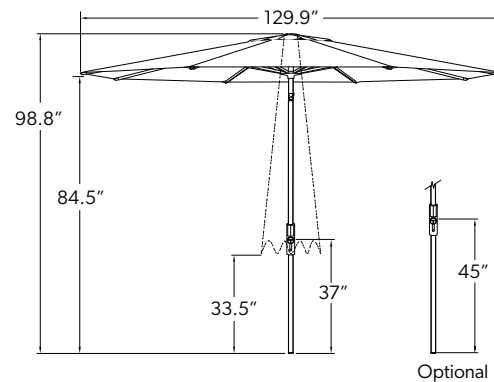

FEATURES

- Powder coated aluminum
- Easy to twist collar tilt function
- Maximum tilt 30°
- Release clamp on housing to easily rotate umbrella 360°
- Functional crank handle automatically returns to center position
- Modernly designed hub, fittings, crank housing, and finial
- Textured two-piece ribbed pole
- Crank lift system
- Residential and commercial use

+ OPTIONS

- Bases and mount kits (pages 52-55, 57)
- Protective cover - PFC902

+ REPLACEMENT PARTS

Frame	UM851-0_
Canopy (SWV)	C8511
37" Bottom pole (Standard)	BP37-850_
45" Bottom pole	BP45-850_

Shipping Information: **Standard Parcel/Courier Services**



AVAILABLE IN



UM850-02
Anthracite



UM850-03
White

SHOWN

Item No: UM850-03
Fabric: 48103S Cast Ocean
Base: BSA120SQ-AW (Base sold separately)

ITEM NO. UM850

Size	9'
Shape	Octagon
Ribs	8
Pole Diameter	1.58"/40mm
Bottom Pole	37"
Vent	SWV
Lift	Crank
Tilt	Collar
Weight	16 lbs.
Cube	3.75
Minimum Base Weight	50 lbs.

FEATURES

- Powder coated aluminum
- Easy to twist collar tilt function
- Maximum tilt 30°
- Release clamp on housing to easily rotate umbrella 360°
- Functional crank handle automatically returns to center position
- Modernly designed hub, fittings, crank housing, and finial
- Textured two-piece ribbed pole
- Crank lift system
- Residential and commercial use

SPECIFICATIONS

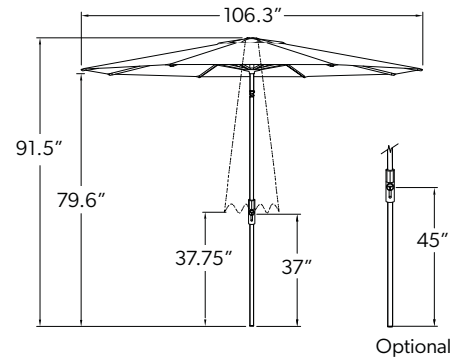

+ OPTIONS

- Bases and mount kits (pages 52-57)
- Protective cover - PFC902

+ REPLACEMENT PARTS

Frame	UM850-0_
Canopy (SWV)	C8509
37" Bottom pole (Standard)	BP37-850_
45" Bottom pole	BP45-850_

Shipping Information: Standard Parcel/Courier Services

9' STARLUX COLLAR TILT

Market Collection



57

sq ft. coverage



AVAILABLE IN



UM800LX-00
Bronze



UM800LX-09
Black

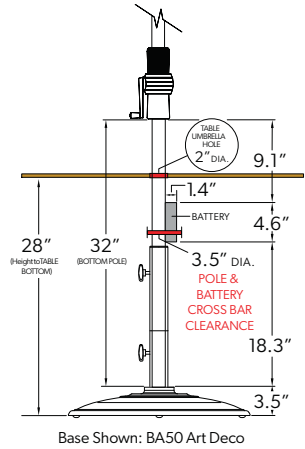

SHOWN

Item No: UM800LX-00
Fabric: 14106 Seasalt
Base: BG500 (Base sold separately)

ITEM NO.	UM800LX	
Size	9'	
Shape	Octagon	
Ribs	8	
Pole Diameter	1.5"	
Bottom Pole	32"	
Vent	SWV	DWV
Lift	Crank	
Tilt	Collar	
Weight	SWV 24 lbs.	DWV 25 lbs.
Cube	2.7	
Minimum Base Weight	50 lbs.	

FEATURES

- Light strips built into (8) ribs for an elegant and modern look
- External rechargeable battery pack with charge level indicator
- Up to 8 hours of battery life and 20,000 lifetime hours
- Built-in USB charging port (5V output)
- Crank lift system with easy to twist collar tilt function
- Maximum tilt 30°
- Color temperature: 4000-4500K
- Powder coated aluminum
- Textured two-piece ribbed pole
- 26 ft. power supply cord
- Water and dust resistant
- Residential and commercial use

SPECIFICATIONS

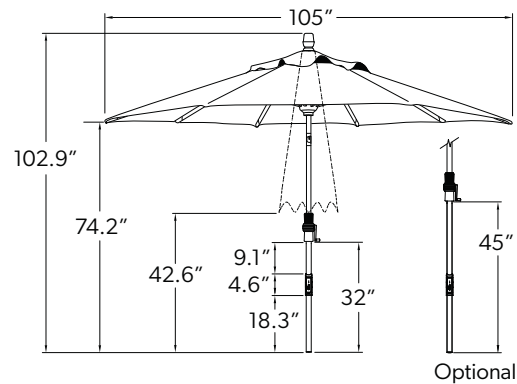

+ OPTIONS

- Designer canopy (page 82)
- Bases and mount kits (pages 52-57)
- Protective cover - PFC902

+ REPLACEMENT PARTS

Frame	UM800LX-0_
Canopy (SWV)	C809
Canopy (DWV)	C809D
32" Bottom pole (Standard)	BP32-800_LXR
45" Bottom pole	BP45-800_LXR

Shipping Information: Standard Parcel/Courier Services



AVAILABLE IN



UM801-00
Bronze



UM801-09
Black

SHOWN

Item No: UM801-09
Fabric: 57012 Cloud
Base: BKM1009 (Base sold separately)

ITEM NO.	UM801	
Size	11'	
Shape	Octagon	
Ribs	8	
Pole Diameter	1.5"	
Bottom Pole	36"	
Vent	SWV	DWV
Lift	Crank	
Tilt	Collar	
Weight	SWV 22 lbs.	DWV 23 lbs.
Cube	1.74	
Minimum Base Weight	80 lbs.	

FEATURES

- Powder coated aluminum
- Easy to twist collar tilt function
- Maximum tilt 30°
- Textured two-piece ribbed pole
- Crank lift system
- Residential and commercial use

SPECIFICATIONS

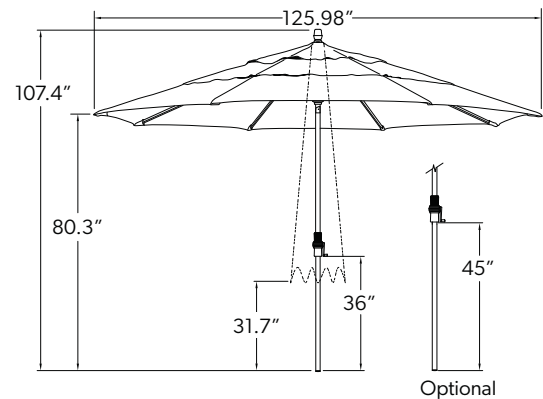

+ OPTIONS

- Designer canopy (page 82)
- Bases and mount kits (pages 52-55, 57)
- Protective cover - PFC902



+ REPLACEMENT PARTS

Frame	UM801-0_
Canopy (SWV)	C811
Canopy (DWV)	C811D
36" Bottom pole (Standard)	BP36-801_
45" Bottom pole	BP45-800_

Shipping Information: Standard Parcel/Courier Services



AVAILABLE IN

-  **UM800-00**
Bronze
-  **UM800-02**
Anthracite
-  **UM800-09**
Black

SHOWN

Item No: UM800-00
Fabric: DC7 Style - 5461 Taupe / 6671 Pathway Pumice Stripe
Base: BG500 (Base sold separately)

ITEM NO.	UM800	
Size	9'	
Shape	Octagon	
Ribs	8	
Pole Diameter	1.5"	
Bottom Pole	32"	
Vent	SWV	DWV
Lift	Crank	
Tilt	Collar	
Weight	SWV 19 lbs.	DWV 20 lbs.
Cube	1.74	
Minimum Base Weight	50 lbs.	

FEATURES

- Powder coated aluminum
- Easy to twist collar tilt function
- Maximum tilt 30°
- Textured two-piece ribbed pole
- Crank lift system
- Residential and commercial use

SPECIFICATIONS

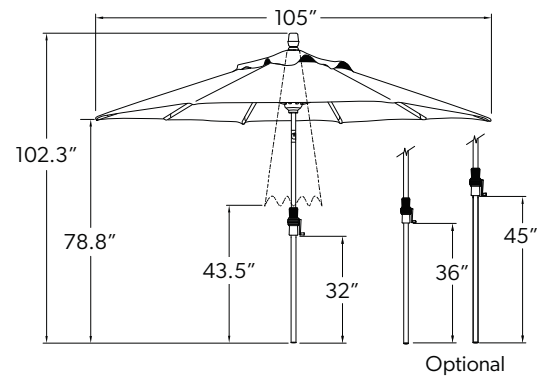

+ OPTIONS

- Designer canopy (page 82)
- Bases and mount kits (pages 52-57)
- Protective cover - PFC902

+ REPLACEMENT PARTS

Frame	UM800-0_
Canopy (SWV)	C809
Canopy (DWV)	C809D
32" Bottom pole (Standard)	BP32-800_
36" Bottom pole	BP36-801_
45" Bottom pole	BP45-800_

Shipping Information: **Standard Parcel/Courier Services**



SHOWN



Umbrella:
UM8009
4853 Vanilla

Base:
BG509

Rug:
Soho Textured Stripe - Black
RG-118-690-35 (5'3"x7'4")



AVAILABLE IN

-  **UM841-SS**
Silver Shadow, Anodized
-  **UM841-00**
Bronze
-  **UM841-09**
Black

SHOWN

Item No: UM841-00
Fabric: 5422 Antique Beige
Base: BKM1000 (Base sold separately)

ITEM NO.	UM841	
Size	11'	
Shape	Octagon	
Ribs	8	
Rib Diameter	0.6"/17mm	
Pole Diameter	1.58"/40mm	
Pole Thickness	0.08"/2mm	
Bottom Pole	32"	
Vent	SWV	DWV
Lift	Crank	
Tilt	Crank	
Weight	SWV 20 lbs.	DWV 23 lbs.
Cube	1.72	
Minimum Base Weight	80 lbs.	

FEATURES

- Commercial grade fiberglass ribs
- Powder coated aluminum pole
- Automatic crank to tilt canopy
- Maximum tilt 30°
- 100% Kevlar mesh lift cord for added strength and durability
- Crank lift system
- Double and single wind vent canopy options
- Residential and commercial use

SPECIFICATIONS

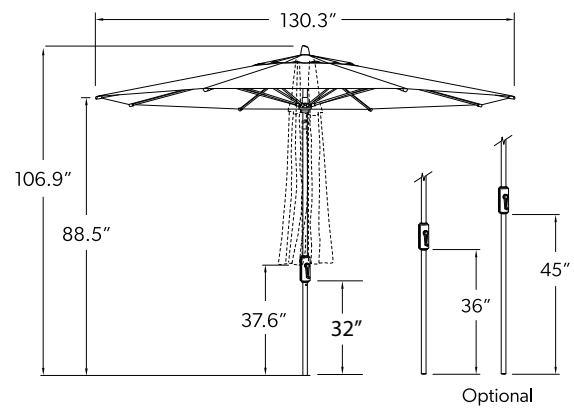

+ OPTIONS

- Bases and mount kits (pages 52-55, 57)
- Protective cover - PFC902



+ REPLACEMENT PARTS

Frame	UM841-__
Canopy (SWV)	C8411
Canopy (DWV)	C8411D
32" Bottom pole (Standard)	BP32-840__
36" Bottom pole	BP36-840__
45" Bottom pole	BP45-840__

Shipping Information: **Standard Parcel/Courier Services**



AVAILABLE IN

-  **UM840-SS**
Silver Shadow,
Anodized
-  **UM840-00**
Bronze
-  **UM840-09**
Black

SHOWN

Item No: UM840-09
Fabric: 5422 Antique Beige
Base: BKM1009 (Base sold separately)

ITEM NO. UM840

Size	9'	
Shape	Octagon	
Ribs	8	
Rib Diameter	0.6"/17mm	
Pole Diameter	1.58"/40mm	
Pole Thickness	0.08"/2mm	
Bottom Pole	32"	
Vent	SWV	DWV
Lift	Crank	
Tilt	Crank	
Weight	SWV 18 lbs.	DWV 19 lbs.
Cube	1.72	
Minimum Base Weight	50 lbs.	

FEATURES

- Commercial grade fiberglass ribs
- Powder coated aluminum pole
- Automatic crank to tilt canopy
- Maximum tilt 30°
- 100% Kevlar mesh lift cord for added strength and durability
- Crank lift system
- Double and single wind vent canopy options
- Residential and commercial use

SPECIFICATIONS

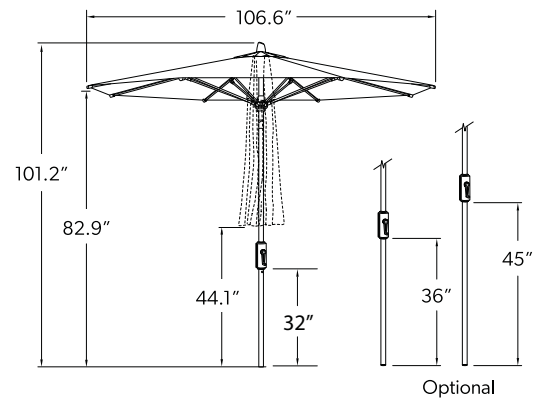

+ OPTIONS

- Bases and mount kits (pages 52-55, 57)
- Protective cover - PFC902



+ REPLACEMENT PARTS

Frame	UM840-__
Canopy (SWV)	C8409
Canopy (DWV)	C8409D
32" Bottom pole (Standard)	BP32-840__
36" Bottom pole	BP36-840__
45" Bottom pole	BP45-840__

Shipping Information: Standard Parcel/Courier Services



AVAILABLE IN

-  **UM847SQ-SS**
Silver Shadow, Anodized
-  **UM847SQ-00**
Bronze
-  **UM847SQ-09**
Black

SHOWN

Item No: UM847SQ-SS
Fabric: 5422 Antique Beige
Base: BKM1009 (Base sold separately)

ITEM NO. UM847SQ

Size	7.5'
Shape	Square
Ribs	4
Rib Diameter	0.6"/17mm
Pole Diameter	1.58"/40mm
Pole Thickness	0.08"/2mm
Bottom Pole	32"
Vent	SWV
Lift	Crank
Tilt	Crank
Weight	SWV 12 lbs.
Cube	1.72
Minimum Base Weight	50 lbs.

FEATURES

- Commercial grade fiberglass ribs
- Powder coated aluminum pole
- Automatic crank to tilt canopy
- Maximum tilt 30°
- 100% Kevlar mesh lift cord for added strength and durability
- Crank lift system
- Double and single wind vent canopy options
- Residential and commercial use

SPECIFICATIONS

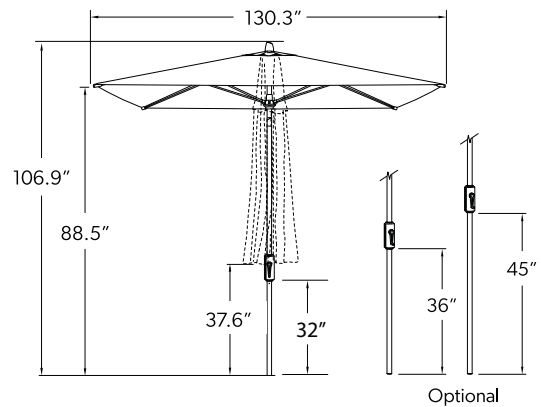

+ OPTIONS

- Bases and mount kits (pages 52-55, 57)
- Protective cover - PFC901





+ REPLACEMENT PARTS

Frame	UM847SQ_
Canopy (SWV)	C847SQ
32" Bottom pole (Standard)	BP32-840_
36" Bottom pole	BP36-840_
45" Bottom pole	BP45-840_

Shipping Information: **Standard Parcel/Courier Services**



AVAILABLE IN

-  **UM812-00**
Bronze
-  **UM812-02**
Anthracite
-  **UM812-03**
White
-  **UM812-09**
Black

SHOWN

Item No: UM812-00D
Fabric: 5461 Taupe
Base: BKM1000 (Base sold separately)

ITEM NO.	UM812	
Size	11'	
Shape	Octagon	
Ribs	8	
Pole Diameter	1.5"	
Bottom Pole	36"	
Vent	SWV	DWV
Lift	Crank	
Tilt	Crank	
Weight	SWV 22 lbs.	DWV 23 lbs.
Cube	1.74	
Minimum Base Weight	80 lbs.	

FEATURES

- Powder coated aluminum
- Automatic crank to tilt canopy
- Maximum tilt 30°
- 100% Kevlar mesh lift cord for added strength and durability
- Crank lift system

SPECIFICATIONS

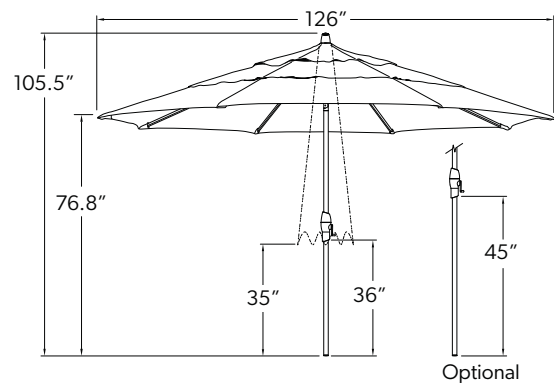

+ OPTIONS

- Designer canopy (page 82)
- Bases and mount kits (pages 52-55, 57)
- Protective cover - PFC902







+ REPLACEMENT PARTS

Frame	UM812-0_
Canopy (SWV)	C811
Canopy (DWV)	C811D
36" Bottom pole (Standard)	BP36-812_
45" Bottom pole	BP45-810_

Shipping Information: Standard Parcel/Courier Services



AVAILABLE IN

-  **UM810-SS**
Silver Shadow, Anodized
-  **UM810-WO**
Weathered Oak
-  **UM810-00**
Bronze
-  **UM810-02**
Anthracite
-  **UM810-03**
White
-  **UM810-09**
Black

SHOWN

Item No: UM810-WO 
Fabric: 58039 Gateway Mist Stripe
Base: BG50SD  (Base sold separately)

ITEM NO.	UM810	
Size	9'	
Shape	Octagon	
Ribs	8	
Pole Diameter	1.5"	
Bottom Pole	32"	
Vent	SWV	DWV
Lift	Crank	
Tilt	Crank	
Weight	SWV 19 lbs.	DWV 20 lbs.
Cube	1.74	
Minimum Base Weight	50 lbs.	

FEATURES

- Powder coated aluminum
- Automatic crank to tilt canopy
- Maximum tilt 30°
- 100% Kevlar mesh lift cord for added strength and durability
- Crank lift system

SPECIFICATIONS

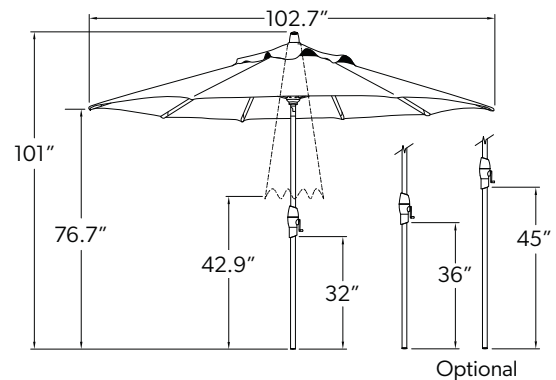

+ OPTIONS

- Designer canopy (page 82)
- Bases and mount kits (pages 52-57)
- Protective cover - PFC902





+ REPLACEMENT PARTS

Frame	UM810-__
Canopy (SWV)	C809
Canopy (DWV)	C809D
32" Bottom pole (Standard)	BP32-810__
36" Bottom pole	BP36-812__
45" Bottom pole	BP45-810__

Shipping Information: **Standard Parcel/Courier Services**



AVAILABLE IN

-  **UM8810RT-00**
Bronze
-  **UM8810RT-02**
Anthracite
-  **UM8810RT-03**
White
-  **UM8810RT-09**
Black

SHOWN

Item No: UM8810RT-03 
 Fabric: 4881 Blue Jay
 Base: BKMSQ1003 (Base sold separately)

ITEM NO. UM8810RT

Size	8'x10'
Shape	Rectangle
Ribs	8
Pole Diameter	1.5"
Bottom Pole	32"
Vent	SWV
Lift	Crank
Tilt	Crank
Weight	22 lbs.
Cube	1.95
Minimum Base Weight	100 lbs.

FEATURES

- Powder coated aluminum
- Automatic crank to tilt canopy
- Maximum tilt 30°
- 100% Kevlar mesh lift cord for added strength and durability
- Crank lift system

SPECIFICATIONS

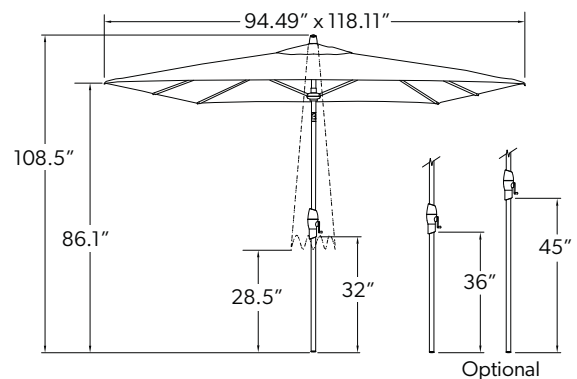

+ OPTIONS

- Bases and mount kits (pages 52-53, 57)
- Protective cover - PFC910

+ REPLACEMENT PARTS



Frame	UM8810RT-0_
Canopy (SWV)	C8810
32" Bottom pole (Standard)	BP32-810_
36" Bottom pole	BP36-812_
45" Bottom pole	BP45-810_

STRIPED FABRICS NOT AVAILABLE ON THIS STYLE.

Shipping Information: Standard Parcel/Courier Services



AVAILABLE IN

-  **UM970-00**
Bronze
-  **UM970-09**
Black

SHOWN

Item No: UM970-09
Fabric: 48910 Dakota Stone Stripe
Base: BW509 (Base sold separately)

ITEM NO.	UM970	
Size	9'	
Shape	Octagon	
Ribs	8	
Pole Diameter	1.5"	
Bottom Pole	36"	
Vent	SWV	DWV
Lift	Crank	
Tilt	Glide	
Weight	SWV 18 lbs.	DWV 19 lbs.
Cube	1.58	
Minimum Base Weight	50 lbs.	

FEATURES

- Powder coated aluminum
- Revolutionary slide to tilt canopy function
- Maximum tilt 22°
- Crank lift system

SPECIFICATIONS

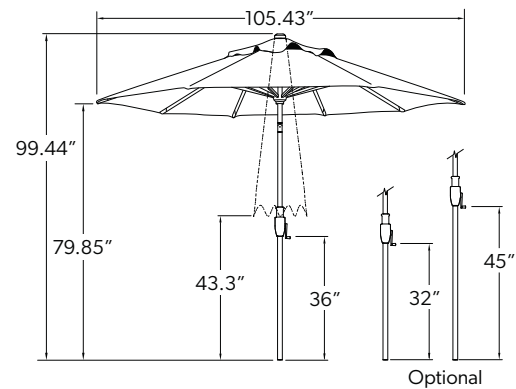

+ OPTIONS

- Designer canopy (page 82)
- Bases and mount kits (pages 52-57)
- Protective cover - PFC902

+ REPLACEMENT PARTS

Frame	UM970-0_
Canopy (SWV)	C809
Canopy (DWV)	C809D
32" Bottom pole	BP32-810_
36" Bottom pole (Standard)	BP36-812_
45" Bottom pole	BP45-810_

Shipping Information: **Standard Parcel/Courier Services**



AVAILABLE IN



UM977-00
Bronze



UM977-09
Black

SHOWN

Item No: UM977-00
Fabric: 4822 Khaki
Base: BW500 (Base sold separately)

ITEM NO. UM977

Size	7.5'
Shape	Octagon
Ribs	8
Pole Diameter	1.5"
Bottom Pole	36"
Vent	SWV
Lift	Crank
Tilt	Glide
Weight	15 lbs.
Cube	1.44
Minimum Base Weight	50 lbs.

FEATURES

- Powder coated aluminum
- Revolutionary slide to tilt canopy function
- Maximum tilt 22°
- Crank lift system
- Great for small areas

SPECIFICATIONS

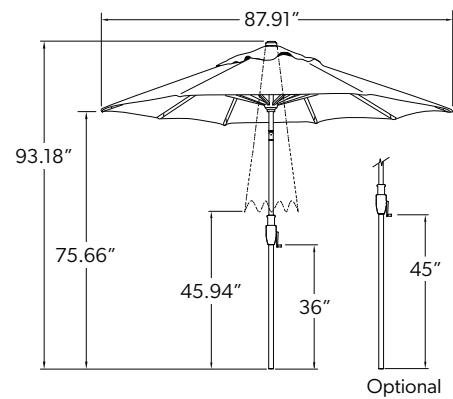

+ OPTIONS

- Bases and mount kits (pages 52-57)
- Protective cover - PFC901

+ REPLACEMENT PARTS

Frame	UM977-0_
Canopy (SWV)	C807
36" Bottom pole (Standard)	BP36-812_
45" Bottom pole	BP45-810_

Shipping Information: Standard Parcel/Courier Services

9' PUSH BUTTON TILT





Market Collection



57
sq ft. coverage



AVAILABLE IN

-  **UM920-00**
Bronze
-  **UM920-02**
Anthracite
-  **UM920-03**
White
-  **UM920-09**
Black

SHOWN

Item No: UM920-03
Fabric: 4838 Lemon
Base: BW503 (Base sold separately)

ITEM NO.	UM920	
Size	9'	
Shape	Octagon	
Ribs	8	
Pole Diameter	1.38" Top Pole	1.5" Bottom Pole
Bottom Pole	32"	
Vent	SWV	DWV
Lift	Crank	
Tilt	Push Button	
Weight	SWV 17 lbs.	DWV 18 lbs.
Cube	1.74	
Minimum Base Weight	50 lbs.	

FEATURES

- Powder coated aluminum
- Manual push button, two-way tilt canopy
- Maximum tilt 30°
- Crank lift system

SPECIFICATIONS

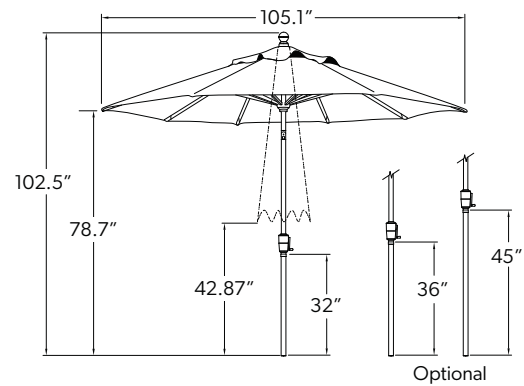

+ OPTIONS

- Designer canopy (page 82)
- Bases and mount kits (pages 52-57)
- Protective cover - PFC902



+ REPLACEMENT PARTS

Frame	UM920-0_
Canopy (SWV)	C809
Canopy (DWV)	C809D
32" Bottom pole (Standard)	BP32-920_
36" Bottom pole	BP36-907_
45" Bottom pole	BP45-920_

Shipping Information: Standard Parcel/Courier Services



AVAILABLE IN

-  **UM907-00**
Bronze
-  **UM907-03**
White
-  **UM907-09**
Black

SHOWN

Item No: UM907-09
Fabric: 4815 Sunset
Base: BW509 (Base sold separately)

ITEM NO. **UM907**

Size	7.5'	
Shape	Octagon	
Ribs	8	
Pole Diameter	1.38" Top Pole	1.5" Bottom Pole
Bottom Pole	36"	
Vent	SWV	
Lift	Crank	
Tilt	Push Button	
Weight	14 lbs.	
Cube	1.45	
Minimum Base Weight	50 lbs.	

FEATURES

- Powder coated aluminum
- Manual push button, two-way tilt canopy
- Maximum tilt 30°
- Crank lift system
- Great for small areas

SPECIFICATIONS

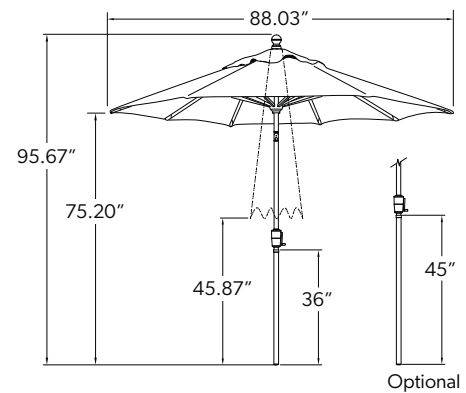

+ OPTIONS

- Bases and mount kits (pages 52-57)
- Protective cover - PFC901

+ REPLACEMENT PARTS

Frame	UM907-0_
Canopy (SWV)	C807
36" Bottom pole (Standard)	BP36-907_
45" Bottom pole	BP45-920_

Shipping Information: Standard Parcel/Courier Services

9' QUAD PULLEY LIFT

Market Collection



57

sq ft. coverage



AVAILABLE IN



UM809-1H
Hardwood

SHOWN

Item No: UM809-1H
Fabric: 56095 Astoria Sunset Stripe
Base: BW500 (Base sold separately)

ITEM NO.	UM809-1H	
Size	9'	
Shape	Octagon	
Ribs	8	
Pole Diameter	1.5"	
Bottom Pole	36"	
Vent	SWV	DWV
Lift	Quad Pulley	
Tilt	n/a	
Weight	SWV 23 lbs.	DWV 24 lbs.
Cube	1.72	
Minimum Base Weight	50 lbs.	

SPECIFICATIONS

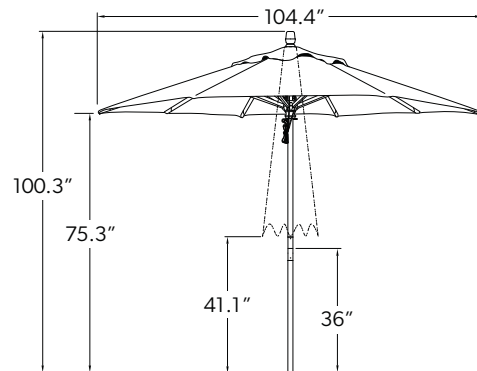

FEATURES

- Quad pulley lift system
- Aluminum alloy locking pin
- FSC hardwood



Our Hardwood umbrella is crafted of FSC - certified from well-managed forests.

Our wood products are distinguished by any of the following characteristics: Organic, Recycled, Reclaimed or Sustainable.

+ OPTIONS

- Designer canopy (page 82)
- Bases and mount kits (pages 52-57)
- Protective cover - PFC902

+ REPLACEMENT PARTS

Frame	UM809-1H
Canopy (SWV)	C809
Canopy (DWV)	C809D
36" Bottom pole	BP36-8091

Shipping Information: Standard Parcel/Courier Services



SHOWN

Umbrella:
UM809-1H
7846 Marbled Meadow

Base:
BG500

Rug:
Paradise Cove - Spa
RP-004-470-80 (7'10" x 10')

FABRIC COLLECTION

100% Solution-Dyed Acrylic
Grade A+

100% Solution-Dyed Acrylic
Grade A

100% Solution-Dyed Polyester
Grade C





FABRIC

Collection

Treasure Garden offers a wide selection of fabrics from acrylic, to our exclusive high performance, environmentally friendly fabric O'bravia®. These fabrics will allow your customers to find the perfect selections to complement their outdoor environment.

TGEx "Quick-Ship" program is available in select fabrics in our 7.5' and 9' Single Wind Vent (SWV) & 11' Double Wind Vent (DWV).
Note: 11' TWIST *tilt* available in SWV only.

CQS "Quick-Ship" program is available in select fabrics and cantilever styles.

For ordering information on our programs - see pages 88-89



GRADE A+ - 100% Solution-Dyed Acrylic



6905 Arbor Sky A+



6906 Arbor Smoke A+



6907 Lagoon Dove A+

GRADE A - 100% Solution-Dyed Acrylic

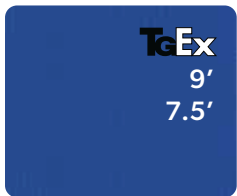

5401 Pacific Blue A



5402 Granite A

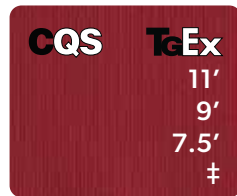

5403 Jockey Red A

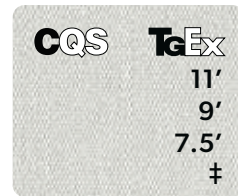

5404 Natural A



5407 Henna A

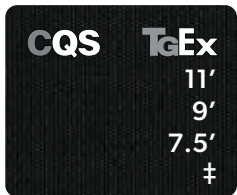

5408 Black A

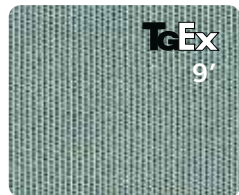

5413 Spa A



5416 Aruba A



5417 Tuscan A



5422 Antique Beige A

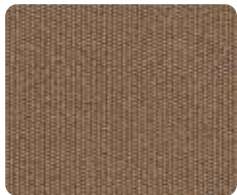

5425 Cocoa A



5438 Buttercup A



5439 Navy A

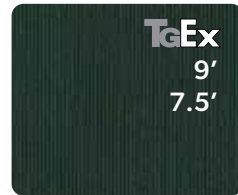

5446 Forest Green A



5453 Canvas A

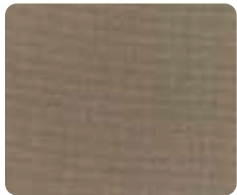

5461 Taupe A

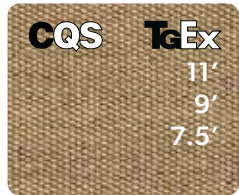

5476 Heather Beige A



5489 Coal A



6407 Aquatic A



6433 Neptune A

‡ Available TGEx fabric for 11' and 9' TWIST *tilt* style.

GRADE A - 100% Solution-Dyed Acrylic (continued)



6457 A
Beacon Ash



6662 A
Harper Steel Stripe



6667 A
Kinzie Smoke Stripe



6668 A
Kinzie Coal Stripe



6670 A
Reliant Coast Stripe



6671 A
Pathway Pumice Stripe



6733 A
Kinzie Royal Stripe



7846 A
Marbled Meadow



7863 A
New Block Smoke Stripe



7865 A
New Block Sea Stripe



8318 A
Sesame Linen



14087 A
Gateway Coast Stripe



14106 A
Seasalt



40428 A
Cast Ash

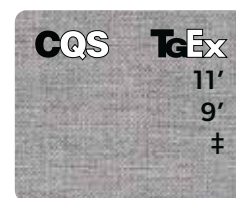

40433 A
Cast Silver



40434 A
Cast Slate



40456 A
Cast Lagoon



40524-01 A
Trusted Fog Stripe



40599-01 A
Direction Linen Stripe

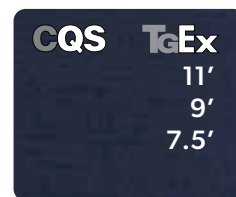

48080 A
Spectrum Indigo



54011 A
Ginkgo



54048 A
Charcoal



48103S A
Cast Ocean



56079 A
Milano Char Stripe



56080 A
Milano Cobalt Stripe



56095 A
Astoria Sunset Stripe



57012 A
Cloud



58039 A
Gateway Mist Stripe

NOTE: Fabric swatches shown are not to scale. Colors may vary slightly from the actual fabric; please refer to the TG Fabric Swatch Book to view true color and detail.

Stripe fabrics not available on rectangles. No Grade A+ on cantilevers.

FABRIC

Collection

GRADE C - 100% Solution-Dyed Polyester

EXCLUSIVE



4800 C
Champagne



4801 C
Cobalt



4803 C
Red



4804 C
Eggshell



4807 C
Auburn



4808 C
Black



4809 C
Burnt Orange

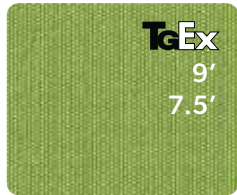

4811 C
Kiwi



4812 C
Silver Linen



4813 C
Spa



4814 C
Straw



4815 C
Sunset

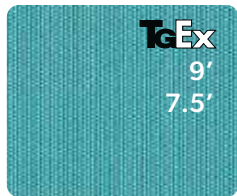

4816 C
Aqua

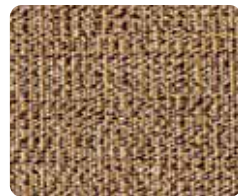

4818 C
Sesame

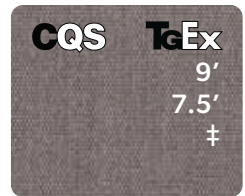

4820 C
Boulder

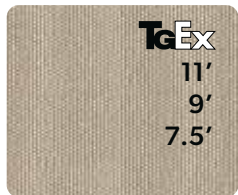

4822 C
Khaki



4825 C
Mocha



4826 C
Sky



4827 C
Chocolate



4834 C
Carbon



4838 C
Lemon

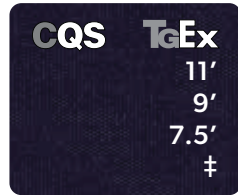

4839 C
Navy



4846 C
Forest Green

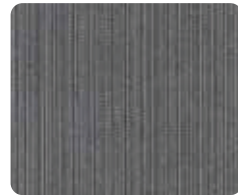

4850 C
Latitude Gray



4851 C
Latitude Navy



4852 C
Sterling



4853 C
Vanilla



4861 C
Taupe

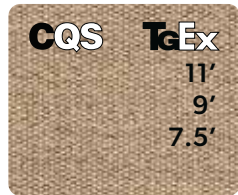

4876 C
Sand



4880 C
Denim

‡ Available TGEEx fabric for 11' and 9' TWIST tilt style.

GRADE C - 100% Solution-Dyed Polyester (continued)

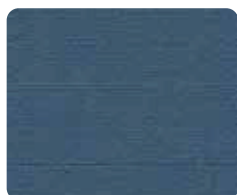

4881 C
Blue Jay



4899 C
Hampton Stripe



48011 C
Ridge Beach



48066 C
Ridge Canyon



48907 C
Tuscan Redwood Stripe

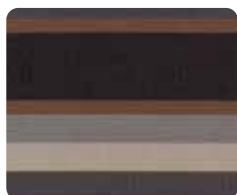

48910 C
Dakota Stone Stripe



48911 C
Providence Navy Stripe



48913 C
Vancouver Coast Stripe



48919 C
Richmond Stone Stripe

NOTE: Fabric swatches shown are not to scale. Colors may vary slightly from the actual fabric; please refer to the TG Fabric Swatch Book to view true color and detail.

Stripe fabrics not available on rectangles or Shanghai.

FABRIC INDEX

Collection

Fabric Item No.	Fabric Name	Swatch Book Page No.	Fabric Grade	Quick-Ship			
				7.5' (SWV)	9' (SWV)	11' (DWV)	Cantilever Quick-Ship
2402	Banana	75L	D*				
2406	Blue Sky	72L	D*				
2407	Henna	74R	D*				
2408	Black	77R	D*				
2410	Pottery	72R	D*				
2412	Really Red	73R	D*				
2429	Macaw	76L	D*				
2439	Navy	74L	D*				
2446	Forest Green	77L	D*				
2470	Walnut	77C	D*				
3400	Champagne	74C	D*				
3409	Terra Cotta	75R	D*				
3450	Charcoal	76R	D*				
3454	Toffee	75C	D*				
3500	Champagne Linen	72C	D*				
3504	Cream	73C	D*				
3518	Sesame Linen	76C	D*				
3539	Indigo	73L	D*				
4800	Champagne	58	C				
4801	Cobalt	67L	C	■	■		
4803	Red	67R	C	■	■	■	
4804	Eggshell	43	C				
4807	Auburn	47	C		■		
4808	Black	70L	C		■		
4809	Burnt Orange	66R	C				
4811	Kiwi	70R	C	■	■		
4812	Silver Linen	57	C				
4813	Spa	49	C				
4814	Straw	60	C				
4815	Sunset	65R	C				
4816	Aqua	63L	C	■	■		
4818	Sesame	59	C				

Fabric Item No.	Fabric Name	Swatch Book Page No.	Fabric Grade	Quick-Ship			
				7.5' (SWV)	9' (SWV)	11' (DWV)	Cantilever Quick-Ship
4820	Boulder	45	C	■	■		■
4822	Khaki	71C	C	■	■	■	
4825	Mocha	69C	C				
4826	Sky	66L	C				
4827	Chocolate	67C	C				
4834	Carbon	65C	C				
4838	Lemon	64R	C	■	■		
4839	Navy	53	C	■	■	■	■
4846	Forest Green	69R	C	■	■		
4850	Latitude Gray	56	C				
4851	Latitude Navy	55	C				
4852	Sterling	63C	C				
4853	Vanilla	66C	C				
4861	Taupe	68C	C				
4876	Sand	70C	C	■	■	■	■
4880	Denim	68L	C				
4881	Blue Jay	51	C				
4899	Hampton Stripe	54	C				
48011	Ridge Beach	61	C				
48066	Ridge Canyon	62	C				
48907	Tuscan Redwood Stripe	48	C				
48910	Dakota Stone Stripe	46	C				
48911	Providence Navy Stripe	51	C				
48913	Vancouver Coast Stripe	50	C				
48919	Richmond Stone Stripe	44	C				
5401	Pacific Blue	48R	A	■	■		
5402	Granite	36C	A				
5403	Jockey Red	29	A	■	■	■	■
5404	Natural	12	A	■	■	■	■
5407	Henna	33L	A		■	■	
5408	Black	27	A	■	■	■	■
5413	Spa	33R	A		■		

*Grade D - AVAILABLE ON ONLY.

FABRIC INDEX

Collection

Fabric Item No.	Fabric Name	Swatch Book Page No.	Fabric Grade				
				7.5' Quick-Ship (SWV)	9' Quick-Ship (SWV)	11' Quick-Ship (DWW)	Cantilever Quick-Ship
5416	Aruba	36R	A				
5417	Tuscan	30	A				
5422	Antique Beige	36L	A		■		
5425	Cocoa	42L	A				
5438	Buttercup	34L	A				
5439	Navy	41R	A	■	■	■	
5446	Forest Green	41C	A	■	■		
5453	Canvas	35L	A		■	■	
5461	Taupe	6	A				
5476	Heather Beige	37L	A	■	■	■	■
5489	Coal	39C	A				
6407	Aquatic	35R	A				
6433	Neptune	40R	A				
6457	Beacon Ash	21	A				
6662	Harper Steel Stripe	26	A				
6667	Kinzie Smoke Stripe	20	A				
6668	Kinzie Coal Stripe	25	A				
6670	Reliant Coast Stripe	19	A				
6671	Pathway Pumice Stripe	5	A				
6733	Kinzie Royal Stripe	17	A				
6905	Arbor Sky	13	A+				
6906	Arbor Smoke	1	A+				
6907	Lagoon Dove	3	A+				
7846	Marbled Meadow	7	A				
7863	New Block Smoke Stripe	2	A				
7865	New Block Sea Stripe	10	A				
8318	Sesame Linen	39L	A				
14087	Gateway Coast Stripe	18	A				
14106	Seasalt	8	A				
40428	Cast Ash	38L	A				
40433	Cast Silver	33C	A		■	■	■
40434	Cast Slate	37L	A				

Fabric Item No.	Fabric Name	Swatch Book Page No.	Fabric Grade				
				7.5' Quick-Ship (SWV)	9' Quick-Ship (SWV)	11' Quick-Ship (DWW)	Cantilever Quick-Ship
40456	Cast Lagoon	11	A				
40524-01	Trusted Fog Stripe	23	A				
40599-01	Direction Linen Stripe	4	A				
48080	Spectrum Indigo	14	A	■	■	■	■
48103S	Cast Ocean	37R	A				
54011	Ginkgo	42C	A				
54048	Charcoal	38C	A				
56079	Milano Char Stripe	22	A				
56080	Milano Cobalt Stripe	16	A				
56095	Astoria Sunset Stripe	29	A				
57012	Cloud	9	A				
58039	Gateway Mist Stripe	24	A				

Note:



is available in select fabrics on our 7.5' and 9' Single Wind Vent (SWV) & 11' Double Wind Vent (DWW). 11' TWIST *tilt* available in SWV only.



‡ is available for 11' and 9' TWIST *tilt* style.



is available in select fabrics and cantilever styles.

‡ 11' and 9' TWIST *tilt* fabric selection for TGEx (SWV only):

- 5403 Jockey Red
- 5404 Natural
- 5408 Black
- 5439 Navy
- 40433 Cast Silver

- 4803 Red
- 4820 Boulder
- 4839 Navy

FABRIC CLEANING & MAINTENANCE INSTRUCTIONS

Collection

General Information

100% Solution-Dyed Acrylic Fabrics:

Grade A+/A

Limited warranty: 5 years against fading



100% Solution-Dyed Polyester Fabrics:

Grade C (Our exclusive 4800 series)

Limited warranty: 4 years against fading



For the complete line of our
Care & Maintenance products
See pages 78-79

MOST STAINS ON SOLUTION-DYED FABRICS CAN BE CLEANED UP WITH TREASURE GARDEN'S UPHOLSTERY & FABRIC CLEANER (TGC-UFC-32) OR A NATURAL MILD SOAP AND WATER SOLUTION. Solution-Dyed fabrics should be cleaned regularly before substances such as dirt, etc., are allowed to accumulate on and become embedded in the fabric. The fabric can be cleaned without being removed from the umbrella. Simply brush off any loose dirt, etc., clean with warm water (no more than 100° F) and a cleaner such as our **Upholstery & Fabric Cleaner (TGC-UFC-32)** or a mild natural soap. Rinse thoroughly to remove cleaner. It may be necessary to re-apply a water repellent treatment, such as our **Upholstery & Fabric Protector (TGC-UFP-32)**. When washing or cleaning, **DO NOT SUBJECT TO EXCESSIVE HEAT** as the fabric will shrink. **DO NOT STEAM PRESS OR DRY IN ELECTRIC OR GAS DRYERS.** Allow fabric to air dry. In case Solution-Dyed fabrics are stored during the winter season, it should be cleaned, allowed to air dry and stored in a dry, well ventilated area. For stubborn stains, please see the stain cleaning chart below for more specific cleaning instructions.

STAIN CLEANING CHART

STAINS	Recommended Cleaning Solutions	STAINS	Recommended Cleaning Solutions
BEER	• liquid detergent, white vinegar	MILDEW	• 1/2 cup of bleach and 1/4 cup natural soap per gallon of water
BERRY	• liquid detergent/ammonia (3-6% water)	MILK	• liquid detergent
BLOOD (dried)	• detergent/ammonia (3-6% water)	NAIL POLISH	• volatile solvent (acetone)
BUTTER	• volatile solvent (acetone)	OIL	• volatile solvent (acetone)
CHARCOAL, PENCIL MARKS	• vacuum, then liquid detergent	ORANGE DRINK	• liquid detergent, water
CATSUP OR MUSTARD	• liquid detergent	PAINT (latex) WET	• liquid detergent, water
CHEWING GUM	• volatile solvent (acetone)	PAINT (latex) DRIED	• paint, oil or grease remover
CHOCOLATE	• liquid detergent, ammonia water	PAINT (oil or lacquer)	• paint, oil or grease remover
COFFEE	• detergent, white vinegar • volatile solvent (acetone)	SHOE POLISH (liquid)	• volatile solvent (acetone)
COLA	• liquid detergent	SHOE POLISH (wax)	• apply heated iron over towel, • volatile solvent (acetone)
CRAYON	• paint, oil or grease remover	SUNTAN LOTION	• Pine Power or pine oil detergent
EGG (raw)	• liquid detergent	TEA	• liquid detergent
GRAPE JUICE	• liquid detergent (water)	TOMATO JUICE	• liquid detergent
GRAVY	• liquid detergent	TREE SAP	• turpentine, liquid detergent
GREASE	• volatile solvent (acetone)	URINE	• liquid detergent, white vinegar
INK	• paint remover, volatile solvent (acetone), detergent	VOMIT	• detergent, water, white vinegar
IRON RUST	• oxalic or citrus acids, water	WATER COLOR	• liquid detergent, water, white vinegar
LIPSTICK	• paint, oil or grease remover	WAX (candle)	• apply heated iron over towel, • volatile solvent (acetone)
MASCARA	• paint remover, volatile solvent (acetone), detergent	WINE	• liquid detergent/ammonia (3-6% water), white vinegar

Protective Furniture Covers

Limited warranty: 1 year against fading and free of manufacturer's defects (stitching, elastics, velcro).

Protective cover fabric should be cleaned periodically with mild soap and water & scrub with soft brush. After cleaning, always rinse thoroughly with clean water and allow to air dry. **DO NOT USE BLEACH.**



SHOWN

Umbrella:
UM800-09D
5453 Canvas

Base:
BG509

Rug:
Mosaic - Pebble Sand
RG-071-268-35 (5'3" x 7'4")

BASE COLLECTION

Commercial
BA150 Series

Steel Base w/casters
BSK120 Series

Aspen w/wheels
BSA120SQ Series

Monaco w/wheels & handle
BKM100 Series
BKMSQ100 Series

Garden
BG50 Series

Art Deco
BA50 Series

Classic
BW50 Series

Base Options

Steel Bases
BS359 Series
BS70_-2.0 Series

Mount Kits
MKC23 | MKG23 Series
MKSB21 Series





BASE Collection



Commercial BA150 Series

- RESIDENTIAL
- COMMERCIAL

FEATURES

- Cast aluminum shell with cast iron core
- Dual-purpose stem

+ OPTIONS

- Aluminum stem for 2" poles - BT2-0_

Cast Aluminum 150 lbs.

AVAILABLE IN

BA1500 Bronze



BA1509 Black



ITEM NO.	Diameter	Weight	Cube	Pallet
BA150	22"	150 lbs.	2.85	12

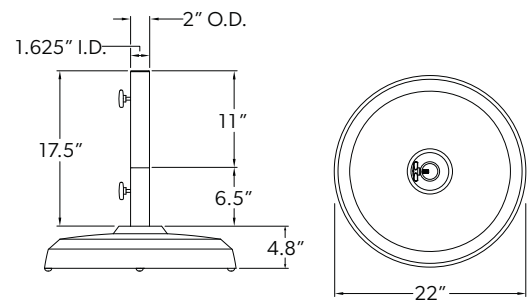

Shipping Information: Truck only

Steel Base w/ casters BSK120 Series

- RESIDENTIAL
- COMMERCIAL

FEATURES

- Accommodates 2" pole diameter
- Dual-purpose stem
- Includes reducer to accommodate 1.5" pole diameter
- (2) Nylon locking casters
- (2) Nylon standard casters

Steel 120 lbs.

AVAILABLE IN

BSK1200 Bronze

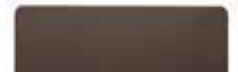

BSK1209 Black



ITEM NO.	Diameter	Weight	Cube	Pallet
BSK120	20.28"	120 lbs.	1.72	16



Locking Casters
Easy to roll and lock your shade where needed.

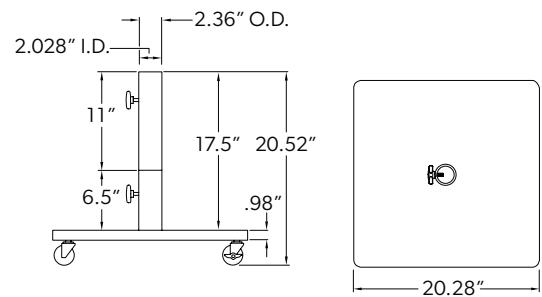

Shipping Information: Truck only



Aspen w/ wheels
BSA120SQ Series

RESIDENTIAL

COMMERCIAL

FEATURES

- Steel base
- Base stem with clamp

Steel 120 lbs.

AVAILABLE IN SHADEMAKER FINISHES

BSA120SQ-SG Shadow Graphite



BSA120SQ-AW Arctic White

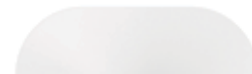

ITEM NO.	Diameter	Weight	Cube	Pallet
BSA120SQ	21.3"	120 lbs.	3	16



Shipping Information: Truck only



Easy to move your shade -
Base rolls easily on 2 wheels.

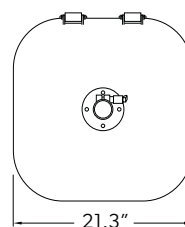
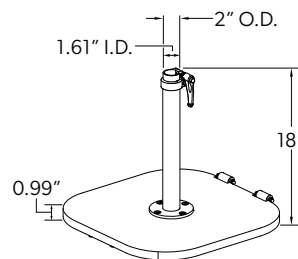

Monaco w/ wheels & handle
BKM100 Round Series
BKMSQ100 Square Series

RESIDENTIAL

COMMERCIAL

FEATURES

- Cast aluminum shell with cast iron core
- Dual-purpose stem

+ OPTIONS

- Add-on weight (30 lbs.) - BW30
- Aluminum stem for 2" poles - BT2-O_

Cast Aluminum 100 lbs.

AVAILABLE IN

BKM1000 BKMSQ1000 Round Square Bronze



BKM1003 BKMSQ1003 Round Square White

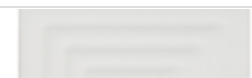

BKM1009 BKMSQ1009 Round Square Black

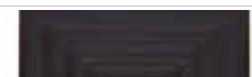

ITEM NO.	Diameter	Weight	Cube	Pallet
BKM100	22"	100 lbs.	2.3	24
BKMSQ100	19.68"	100 lbs.	1.8	24



Shipping Information: Truck only



Easy to move your shade -
Base rolls easily on 2 wheels.

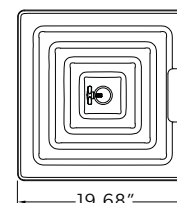
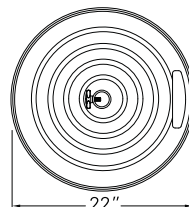
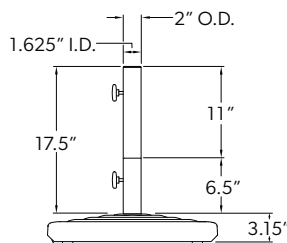

BASE Collection



Garden BG50 Series

RESIDENTIAL

FEATURES

- Cast aluminum shell with cast iron core
- Dual-purpose stem

+ OPTIONS

- Add-on weight (30 lbs.) - BW30
- Aluminum stem for 2" poles - BT2-0_ (BT2 not available in SD Sand)

ITEM NO.	Diameter	Weight	Cube	Pallet
BG50	19.5"	50 lbs.	1.58	40



Cast Aluminum 50 lbs.

AVAILABLE IN

BG500	Bronze	
BG502	Anthracite	
BG503	White	
BG509	Black	
BG50SD	Sand	

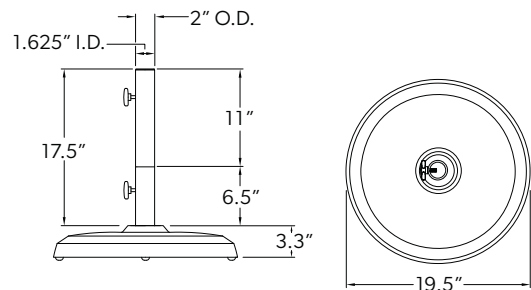

Shipping Information: Standard Parcel/Courier Services

Art Deco BA50 Series

RESIDENTIAL

FEATURES

- Cast aluminum shell with cast iron core
- Dual-purpose stem

+ OPTIONS

- Add-on weight (30 lbs.) - BW30
- Aluminum stem for 2" poles - BT2-0_

ITEM NO.	Diameter	Weight	Cube	Pallet
BA50	20.9"	50 lbs.	1.49	40



Cast Aluminum 50 lbs.

AVAILABLE IN

BA500	Bronze	
BA509	Black	

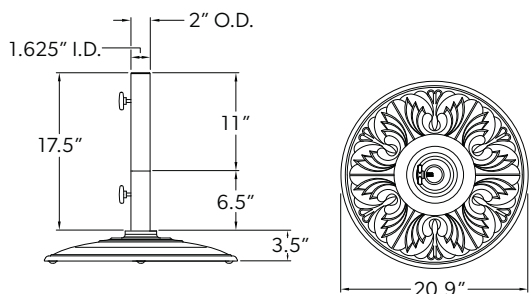

Shipping Information: Standard Parcel/Courier Services

**Classic
BW50 Series**

RESIDENTIAL

FEATURES

- Cast iron
- Dual-purpose stem





+ OPTIONS

- Add-on weight (30 lbs.) - BW30
- Aluminum stem for 2" poles - BT218_

ITEM NO.	Diameter	Weight	Cube	Pallet
BW50	19.3"	50 lbs.	1.33	40

Cast Iron 50 lbs.

AVAILABLE IN

BW500	Bronze	
BW502	Anthracite	
BW503	White	
BW509	Black	

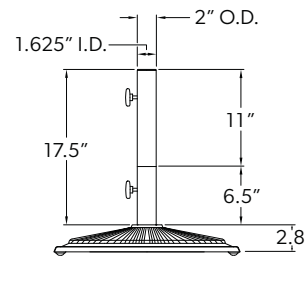

Shipping Information: Standard Parcel/Courier Services

BASE OPTIONS

Add-On Weight

The patented BW30 is an optional cast iron 30 lb. weight that can be added onto our 50 lb. and 100 lb. bases.

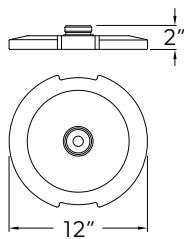

Cast Iron 30 lbs.

ITEM NO.

BW30	30 lbs. Add-On Weight
------	-----------------------

SPECIFICATIONS

Diameter	12"
Weight	30 lbs.
Cube	0.51
Pallet	99

Note:

Recommended for use with free-standing umbrella applications.

Aluminum Stem for 2" Poles

The optional Aluminum Stem accommodates larger pole diameter market umbrellas. *Not designed for steel bases.*

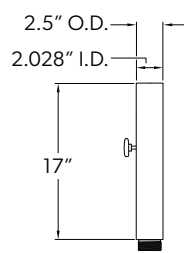

SPECIFICATIONS

Height	17"
Weight	3 lbs.
Cube	0.2

Aluminum Stem
for cast aluminum bases

ITEM NO.

BT2-00	Bronze
BT2-02	Anthracite
BT2-03	White
BT2-09	Black

Aluminum Stem
for BW50 series only

ITEM NO.

BT2180	Bronze
BT2182	Anthracite
BT2183	White
BT2189	Black

BASE Collection



Steel
BS359 Series

RESIDENTIAL

Steel 35 lbs.
AVAILABLE IN

FEATURES

- Dual-purpose stem

BS359	Black	
-------	-------	---

ITEM NO.	Diameter	Weight	Cube	Pallet
BS359	18"	35 lbs.	1.03	60

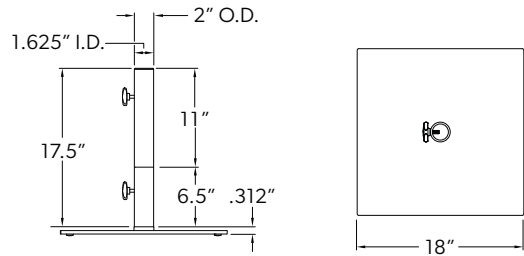

Note: NOT recommended for free-standing umbrella applications.

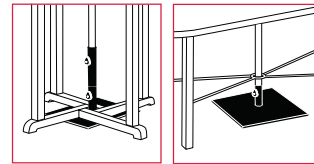

Under-the-table applications

Shipping Information: Standard Parcel/Courier Services



Steel
BS70_-2.0 Series

RESIDENTIAL
COMMERCIAL

Steel 70 lbs.
AVAILABLE IN

FEATURES

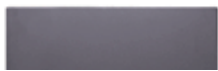
- Accommodates 2" pole diameter
- Dual-purpose stem
- Includes reducer to accommodate 1.5" pole diameter

BS700-2.0	Bronze	
BS702-2.0	Anthracite	
BS703-2.0	White	
BS709-2.0	Black	

ITEM NO.	Diameter	Weight	Cube	Pallet
BS70_-2.0	19"	70 lbs.	1.25	32

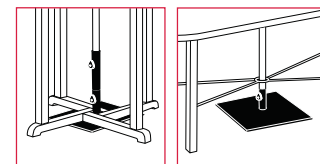
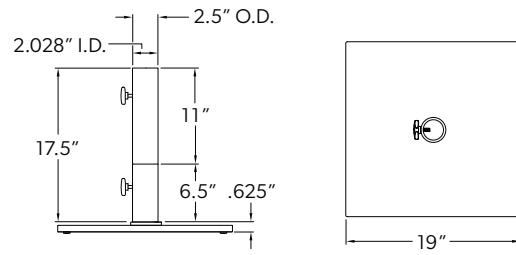

Under-the-table applications

Shipping Information: Standard Parcel/Courier Services



Mount Kits for Market Umbrellas

The concrete and in-ground mount kits are specifically designed to provide a secure and permanent mounting solution for market umbrellas. See page 19 for cantilevers.

- RESIDENTIAL
- COMMERCIAL

MKC23 | Concrete
Includes: Adapter plate and expansion bolts.
External Stem required (sold separately).



MKG23 | In-Ground
Includes: In-ground fitting.
External Stem required (sold separately).



ITEM NO.	Mount Kits	Plate Diameter	Thickness	Overall Depth	Weight	Cube	Case Pack	Case Weight	Case Cube
MKC23	Concrete Mount Kit	8.46"	.63"	n/a	7.76 lbs.	0.16	5	43 lbs.	0.94
MKG23	In-Ground Mount Kit	8.46"	.63"	19.75"	16.50 lbs.	0.91	1	18.26 lbs.	0.91

Available in Silver Anodized finish only. Can be ordered individually or case pack.

Note: External Stem MKSB21 is required and sold separately.

External Stem MKSB21 Series

FEATURES

- Accommodates up to 1.6" center pole diameter
- Base stem clamp

Includes: Stem bolts.

Note: Required for MKC23 and MKG23 Mount Kits (sold separately).

Cast Aluminum

AVAILABLE IN SHADEMAKER FINISHES

MKSB21-SG Shadow Graphite



MKSB21-AB Architectural Bronze



MKSB21-AW Arctic White



MKSB21-SD Sand



ITEM NO.	Diameter	Weight	Cube
MKSB21	8.46"	5.4 lbs.	0.72

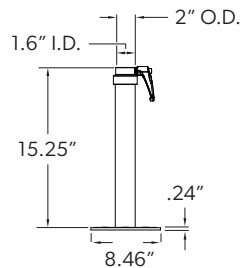

Shown:
External Stem +
Concrete Mount Kit

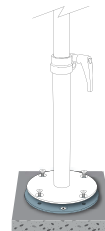

Shown:
External Stem +
In-Ground Mount Kit

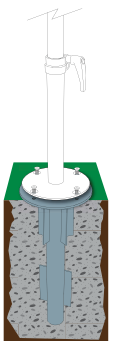

UMBRELLA LIGHT COLLECTION

EVO
Dual-Light Sound Pod
with Bluetooth® Speaker

Luna Pro
Multicolor Umbrella Light
with Bluetooth® Speaker

Halo
Umbrella Light

SHOWN
Umbrella:
AKZP13-09D
40434 Cast Slate

Umbrella Light:
LUNAPRO-09





UMBRELLA LIGHT

Collection



EVO Dual-Light Sound Pod with Bluetooth® Speaker



ITEM NO.

EVO-03
EVO-09

White
Black

Diameter

Weight

Cube

Case
Pack

Case
Weight

Case
Cube

8.68"

7 lbs.

0.72

4

32

3.53

FEATURES

- 51 LED Lights
- Up to 8 hours of battery life
- Compatible with Bluetooth® devices
- Umbrella light with self-adjusting clamp
- Integrated bass speaker
- Black unit comes with a warm light
Color temperature: 2800k-3200k, 30 Lumens
- White unit comes with a cool light
Color temperature: 6000k-6700k, 30 Lumens
- USB port to charge electronic devices (5V output)
- Water and dust resistant
- Power supply included

The EVO dual-light sound pod is a multifunctional umbrella and table light with built in surround sound Bluetooth speakers, adding ambiance and entertainment to any outdoor setting. What makes this product truly special is that in addition to the integrated umbrella light with Bluetooth speakers, similar to our Luna Pro, it also includes a table light element and an integrated bass speaker that provides a crisp surround sound experience outdoors.

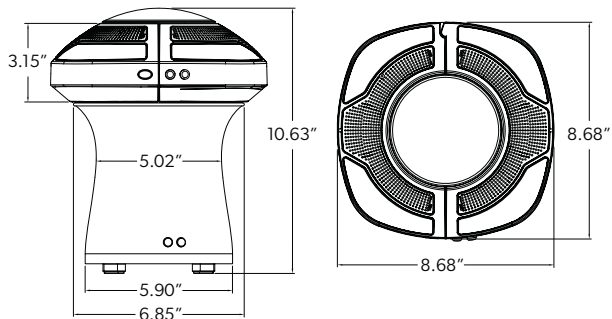

Transform your outdoor space with ambiance and surround sound with our dual-light sound pod.



Luna Pro Multicolor Umbrella Light with Bluetooth® Speaker



FEATURES

- Luna Pro APP to control light features
- Android OS and Apple iOS compatible
- Compatible with Bluetooth® devices
- 160 LED Lights
- Up to 6 hours of battery life
- Color temperature: 3000k
- Self-adjusting clamp
- Power supply included

ITEM NO.

ITEM NO.		Diameter	Weight	Cube	Case Pack	Case Weight	Case Cube
LUNAPRO-00	Bronze	9.84"	4 lbs.	0.32	6	24 lbs.	1.9
LUNAPRO-09	Black						

Designed for the ultimate in illumination and entertainment, the Luna Pro adds convenience and ambiance-rich experiences to the outdoors. Enhanced sound and multi-colored lighting options are featured for easily turning any outdoor gathering into an event. Control lights and features through the Luna Pro APP from any compatible Bluetooth-enabled device.

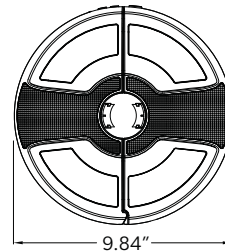
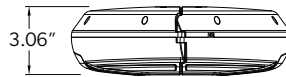

Halo Umbrella Light

FEATURES

- 26 LED Lights
- Up to 6 hours of battery life
- Color temperature: 4000k, 80 Lumens
- Self-adjusting clamp
- Rechargeable battery pack and power supply included

ITEM NO.

ITEM NO.		Diameter	Weight	Cube	Case Pack	Case Weight	Case Cube
HALO-00	Bronze	9.45"	3 lbs.	0.28	6	18 lbs.	1.67
HALO-09	Black						

The Halo is the evolution of the award-winning Vega light. Features the same user-friendly clamp on function, but with an upgraded modern design. Elevate your outdoor space with a Halo light to add ambiance with style.

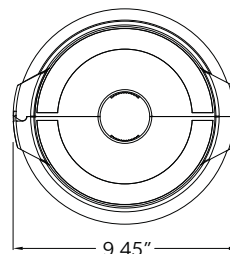
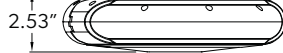

OUTDOOR RUG COLLECTION

PLATINUM COLLECTION

Paradise Cove - Spa
Desert Sunset - Orange
Illusion - Black Mirage
Trellis - Stone Gray



GOLD COLLECTION

Reflections - Ocean Blue
North Shore - Sky Blue
Seaside Harbor - Blue
South Beach - Spectrum
Prism - Taupe
Canyon - Taupe
Sand Dune - Textured Beige
North Shore - Pebble
Moroccan - Textured Taupe
Cobblestone - Gray
Mosaic - Pebble Sand
Soho Textured Stripe - Black



SILVER COLLECTION

Geo - Black
Athens - Silver



SHOWN
Umbrella:
UM810-00
40456 Cast Lagoon

Base:
BG500

Rug:
 South Beach - Spectrum
RG-533-050-35 (5'3" x 7'4")

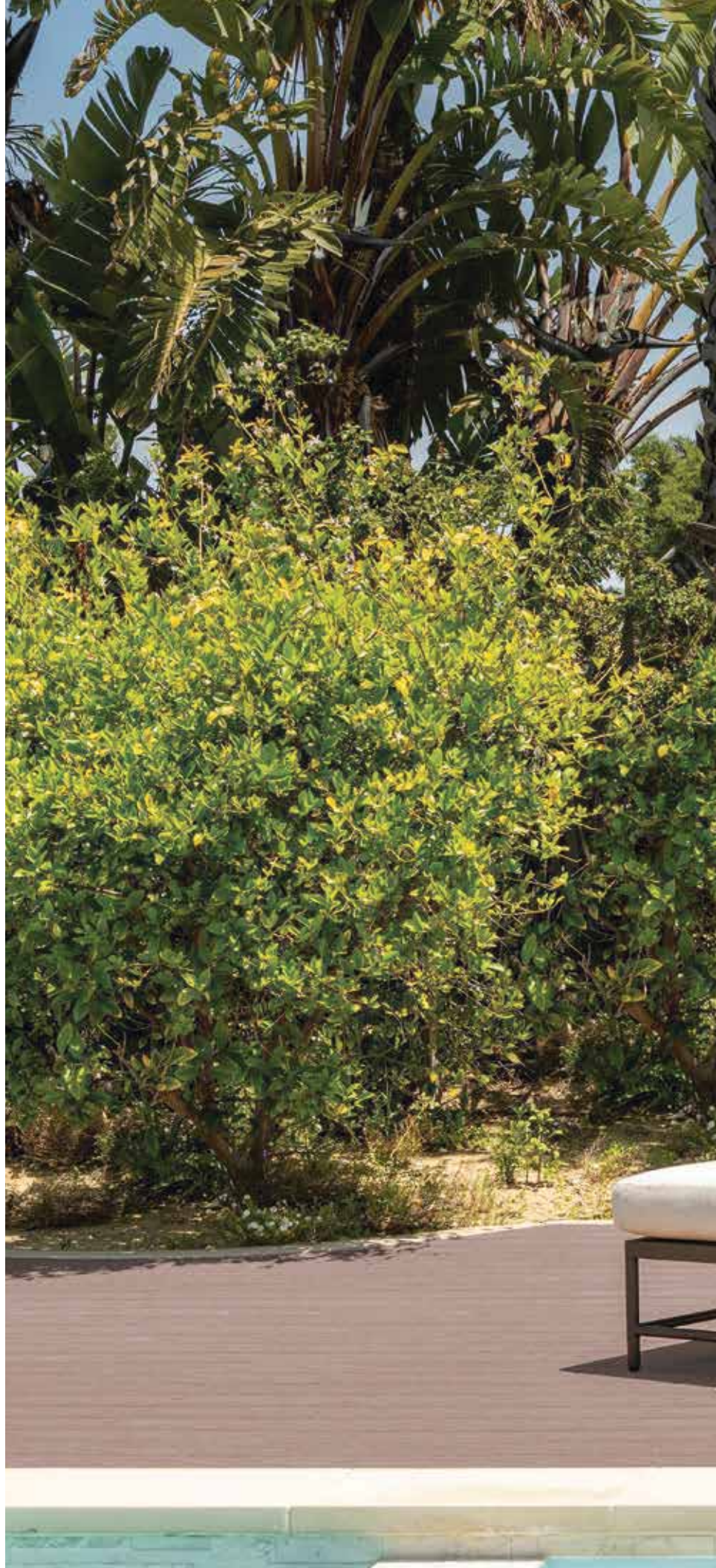



The PLATINUM Collection

Our PLATINUM Collection, meticulously crafted with eco-friendly materials to bring a contemporary design that perfectly blends softness and vibrant color palettes. Experience the epitome of elegance and comfort as these rugs accentuate your outdoor living environment with their stylish aesthetics and captivating hues.

Crafted from 100% recycled polyester, these rugs offer both sustainability and durability, while their UV protection ensures long-lasting beauty under the sun.

- 100% Recycled polyester
- Easy to clean with mild soap
- 1-Year fade warranty
- Made in Turkey



Paradise Cove - Spa

ITEM NO.	Size	Weight	Cube
RP-004-470-80	7'10" x 10'	19 lbs.	1.13
RP-004-470-35	5'3" x 7'4"	9 lbs.	.53



Desert Sunset - Orange

ITEM NO.	Size	Weight	Cube
RP-001-910-80	7'10" x 10'	19 lbs.	1.13
RP-001-910-35	5'3" x 7'4"	9 lbs.	.53



Illusion - Black Mirage

ITEM NO.	Size	Weight	Cube
RP-505-360-80	7'10" x 10'	21 lbs.	1.13
RP-505-360-35	5'3" x 7'4"	10 lbs.	.53

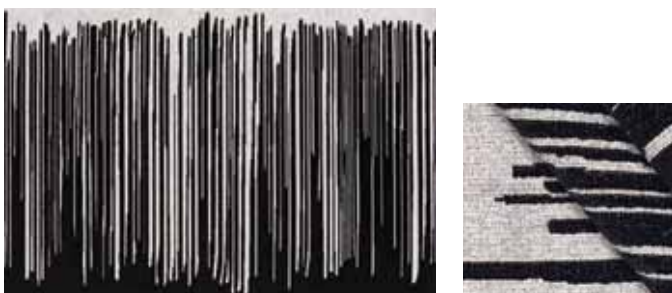

Trellis - Stone Gray NEW

ITEM NO.	Size	Weight	Cube
RP-008-350-80	7'10" x 10'	21 lbs.	1.13
RP-008-350-35	5'3" x 7'4"	10 lbs.	.53

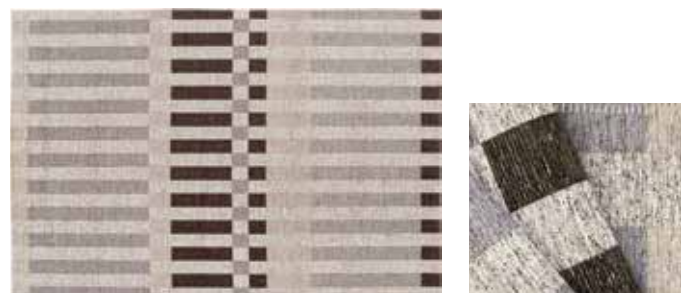

Shipping Information: 5'3" x 7'4" Standard Parcel/Courier Services / 7'10" x 10' Truck Only (Oversized item, additional shipping costs will incur)



The **GOLD** Collection

Our popular **GOLD** Collection includes on-trend designs combined with rich textures and vivid colorations. This collection offers gorgeous designs at an exceptional value, sure to elevate your outdoor space to a new level of sophistication.

Constructed with 100% Polypropylene multi-ply cabled heat-set yarns that offer a luxurious feel with excellent durability.

- 100% UV Stable Polypropylene
- Easy to clean with mild soap
- 1-Year fade warranty
- Made in Belgium

Reflections - Ocean Blue

ITEM NO.	Size	Weight	Cube
RG-334-369-80	7'10" x 10'	24 lbs.	2
RG-334-369-35	5'3" x 7'4"	12 lbs.	.93



North Shore - Sky Blue

ITEM NO.	Size	Weight	Cube
RG-097-365-80	7'10" x 10'	24 lbs.	2
RG-097-365-35	5'3" x 7'4"	12 lbs.	.93

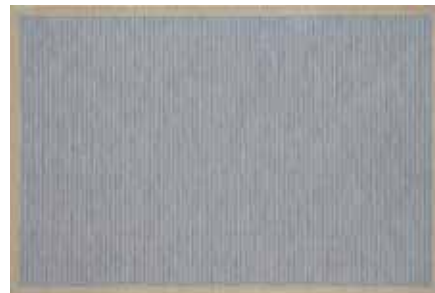

Seaside Harbor - Blue

ITEM NO.	Size	Weight	Cube
RG-253-099-80	7'10" x 10'	24 lbs.	2
RG-253-099-35	5'3" x 7'4"	12 lbs.	.93



South Beach - Spectrum

ITEM NO.	Size	Weight	Cube
RG-533-050-80	7'10" x 10'	24 lbs.	2
RG-533-050-35	5'3" x 7'4"	12 lbs.	.93



OUTDOOR RUG

Gold Collection



Prism - Taupe

ITEM NO.	Size	Weight	Cube
RG-252-560-80	7'10" x 10'	24 lbs.	2
RG-252-560-35	5'3" x 7'4"	12 lbs.	.93



Canyon - Taupe

ITEM NO.	Size	Weight	Cube
RG-203-651-80	7'10" x 10'	24 lbs.	2
RG-203-651-35	5'3" x 7'4"	12 lbs.	.93



Sand Dune - Textured Beige

ITEM NO.	Size	Weight	Cube
RG-204-651-80	7'10" x 10'	24 lbs.	2
RG-204-651-35	5'3" x 7'4"	12 lbs.	.93



North Shore - Pebble

ITEM NO.	Size	Weight	Cube
RG-097-965-80	7'10" x 10'	24 lbs.	2
RG-097-965-35	5'3" x 7'4"	12 lbs.	.93

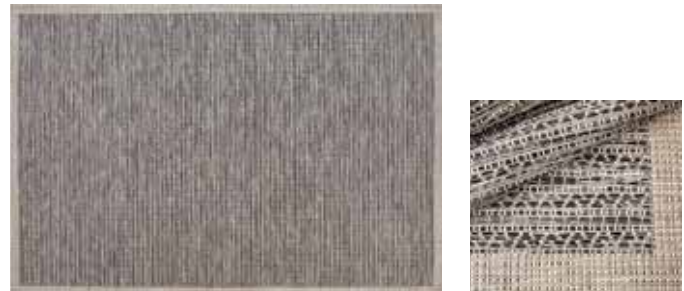

Shipping Information: 5'3" x 7'4" Standard Parcel/Courier Services / 7'10" x 10' Truck Only (Oversized item, additional shipping costs will incur)



Moroccan - Textured Taupe

<i>ITEM NO.</i>	Size	Weight	Cube
RG-011-950-80	7'10" x 10'	24 lbs.	2
RG-011-950-35	5'3" x 7'4"	12 lbs.	.93



Cobblestone - Gray

<i>ITEM NO.</i>	Size	Weight	Cube
RG-461-388-80	7'10" x 10'	24 lbs.	2
RG-461-388-35	5'3" x 7'4"	12 lbs.	.93

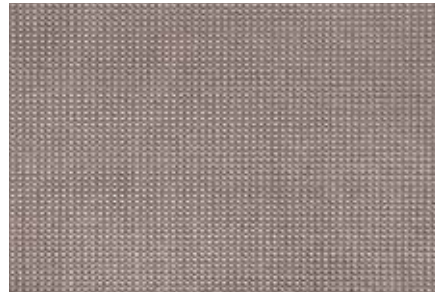

Mosaic - Pebble Sand

<i>ITEM NO.</i>	Size	Weight	Cube
RG-071-268-80	7'10" x 10'	24 lbs.	2
RG-071-268-35	5'3" x 7'4"	12 lbs.	.93



Soho Textured Stripe - Black

<i>ITEM NO.</i>	Size	Weight	Cube
RG-118-690-80	7'10" x 10'	24 lbs.	2
RG-118-690-35	5'3" x 7'4"	12 lbs.	.93

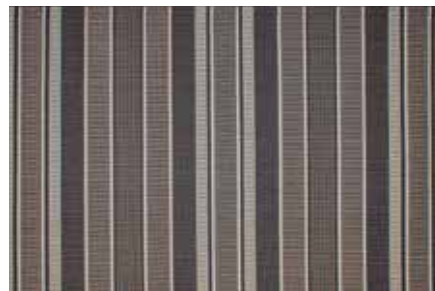

Shipping Information: 5'3" x 7'4" Standard Parcel/Courier Services / 7'10" x 10' Truck Only (Oversized item, additional shipping costs will incur)

OUTDOOR RUG

Silver Collection



The SILVER Collection

Experience the perfect blend of luxury and value with our SILVER Collection, where impeccable design meets unbeatable affordability, all without compromising the comfort and appeal of an outdoor rug.

Constructed with 100% Polypropylene yarns, in all-weather construction, that are stain & soil resistant with UV stabilizers to provide an excellent value.

- 100% UV Stable Polypropylene
- Easy to clean with mild soap
- 1-Year fade warranty
- Made in Belgium

Geo - Black

ITEM NO.	Size	Weight	Cube
RS-404-993-80	7'10" x 10'	19 lbs.	2
RS-404-993-35	5'3" x 7'4"	10 lbs.	.93

Athens - Silver

ITEM NO.	Size	Weight	Cube
RS-607-637-80	7'10" x 10'	21 lbs.	2
RS-607-637-35	5'3" x 7'4"	9 lbs.	.93



Shipping Information: 5'3" x 7'4" Standard Parcel/Courier Services / 7'10" x 10' Truck Only (Oversized item, additional shipping costs will incur)

Rug Tower Display

ITEM NO.	Finish	Size	Weight	Cube
RTD-09	Black	25" W x 25" D x 53" H	52 lbs.	19.05

FEATURES

- Displays up to (6) Treasure Garden rugs
- (5) Polyurethane wheels with (1) locking wheel
- Black - powder coated steel





SHOWN

Umbrella:
UM800-09
5403 Jockey Red

Rug:
Geo - Black
RS-404-993-35 (5'3" x 7'4")

TG CARE COLLECTION

 Protective Furniture Covers

Care and Maintenance Products







Protective Furniture Covers

Protect your investment all year round.

The Protective Furniture Covers are made with a Treasure Garden exclusive fabric. Designed to be durable, breathable, and water resistant and will not crack or peel like vinyl. All covers come with a one-year limited warranty.

Furniture covers features:

- Spring cinch lock to secure protective cover into place for a snug fit
- Convenient storage bag to store away cover when not in use
- Durable coated polyester 300D gray fabric
- UPF 50+ fabric



NEW PACKAGING & STORAGE!

Convenient storage bag with handle and zipper as well as merchandising your store.



Front



Back

NEW STRONGER FABRIC!

More durable and longer lasting.



NEW UPDATED CATEGORY COLORS!

Easily identify categories and styles for your customers.



How to measure for your protective furniture cover

W = Width is measured from the (widest point) from the right side to left side.
D = Depth is measured from front to back at its (deepest point).

H = Height is measured from the ground to the (highest point) of the piece.
Dia = Diameter is measured from the (widest point) across the table top.



Modular Outdoor

(R) Right End (Left Facing)

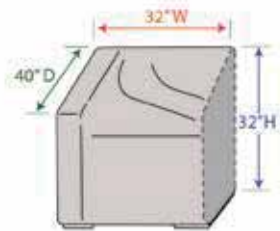

(M) Middle

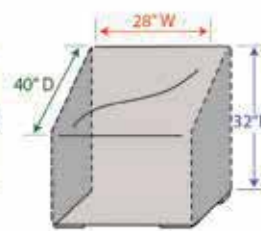

(L) Left End (Right Facing)

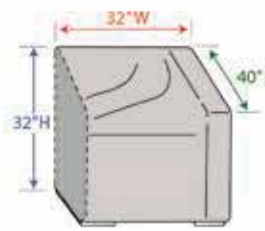

(C) Corner

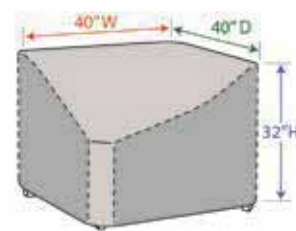

(E) Extension

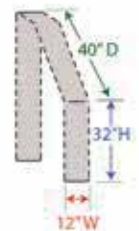

(WR) Wedge Right End (Left Facing)

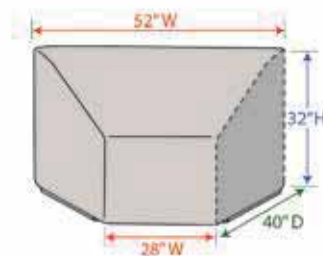

(WC) Wedge Center

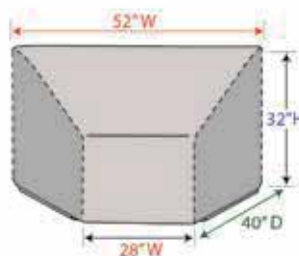

(WL) Wedge Left End (Right Facing)

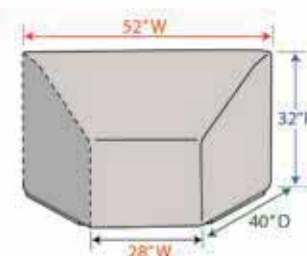

NOTE:

- Style codes for easy identification. **(E)**
- Modular Extension style allows greater flexibility for larger styles.
- Color ● = zipper side (OPEN)

Modular Cover System

Our innovative modular cover system offers uniquely designed protective furniture covers to cover most modular styles. All styles can be joined together to cover the entire modular set, no matter what configuration.



The (8) modular covers are interchangeable and can be zipped together to create one complete unit.

How to join styles together...





1. Zip covers together to desired configuration.







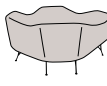
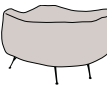
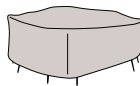
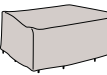
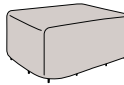
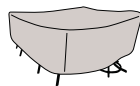
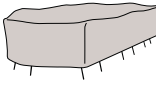



2. Cinch ties to secure covers to furniture.

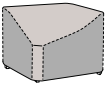

DINING TABLES						
ITEM	ITEM NO.	DESCRIPTION	SIZE	WT (LBS)/CTN	CUBE/CTN	CASE PACK
 	PFC530	30" Bistro Table & Chairs w/4 ties, elastic, spring cinch lock	33" W x 60" D x 36" H	34	3.3	10
	PFC536	36" Round/Square Bistro Table & Chairs w/4 ties, elastic, spring cinch lock	70" Dia. x 36" H	38	3.3	8
	PFC551	48" Round/Square Table & Chairs w/4 ties, elastic, spring cinch lock	84" Dia. x 36" H	37	3.3	6
	PFC571	54" Round/Square Table & Chairs w/6 ties, elastic, spring cinch lock	92" Dia. x 36" H	28	3.3	4
	PFC590	60" Round/Square Table & Chairs w/8 ties, elastic, spring cinch lock	108" Dia. x 36" H	33	3.3	4
	PFC592	Small Oval/Rectangle Table & Chairs w/8 ties, elastic, spring cinch lock	72" W x 90" D x 36" H	37	3.3	6
	PFC594	Medium Oval/Rectangle Table & Chairs w/8 ties, elastic, spring cinch lock	80" W x 108" D x 36" H	31	3.3	4
	PFC596	Large Oval/Rectangle Table & Chairs w/8 ties, elastic, spring cinch lock	80" W x 132" D x 36" H	37	3.3	4
	PFC598	X-Large Oval/Rectangle Table & Chairs w/8 ties, elastic, spring cinch lock	88" W x 156" D x 36" H	42	3.3	4

Note: Can be ordered individually or case pack.

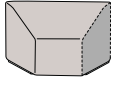
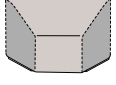
**MODULAR OUTDOOR**

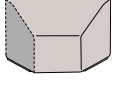
ITEM	ITEM NO.	DESCRIPTION	CODE	SIZE	WT (LBS)/CTN	CUBE/CTN	CASE PACK
	PFC401	Modular Right End (Left Facing) Fits End Sectional w/elastic & spring cinch lock		32" W x 40" D x 32" H	37	3.3	18
	PFC402	Modular Armless (Middle) Fits Middle Sectional w/elastic & spring cinch lock		28" W x 40" D x 32" H	37	3.3	24
	PFC403	Modular Left End (Right Facing) Fits End Sectional w/elastic & spring cinch lock		32" W x 40" D x 32" H	37	3.3	18
	PFC404	Modular Corner Fits Corner Sectional w/elastic & spring cinch lock		40" W x 40" D x 32" H	41	3.3	18
	PFC405	Modular Extension Extends Sectionals w/elastic & spring cinch lock		12" W x 40" D x 32" H	35	3.3	36
	PFC406-R	Modular Wedge Right End (Left Facing) Fits Wedge End Sectional w/elastic & spring cinch lock		52" W x 40" D x 32" H (28" W - Front)	38	3.3	16
	PFC406-C	Modular Wedge (Center) Fits Wedge Corner Sectional w/elastic & spring cinch lock		52" W x 40" D x 32" H (28" W - Front)	36	3.3	18
	PFC406-L	Modular Wedge Left End (Right Facing) Fits Wedge End Sectional w/elastic & spring cinch lock		52" W x 40" D x 32" H (28" W - Front)	37	3.3	16

CHAIRS & CHAISES



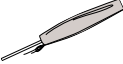
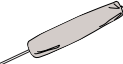
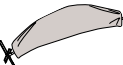
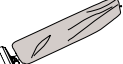
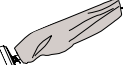

ITEM	ITEM NO.	DESCRIPTION	SIZE	WT (LBS)/CTN	CUBE/CTN	CASE PACK
	PFC115	Dining Chair w/elastic, spring cinch lock	28" W x 33" D x 35" H	23	3.3	10
	PFC116	Counter Height Chair w/elastic, spring cinch lock	28" W x 33" D x 43" H	39	3.3	16
	PFC117	Bar Height Chair w/elastic, spring cinch lock	28" W x 33" D x 49" H	25	3.3	10
	PFC119S	Small Chaise w/4 ties, elastic, spring cinch lock	32" W x 80" D x 42" H (20" H - Front)	25	3.3	6
	PFC119L	Large Chaise w/4 ties, elastic, spring cinch lock	36" W x 86" D x 42" H (20" H - Front)	28	3.3	6

Key: W - Width / D - Depth / H - Height | Dia. - Diameter

UMBRELLA COVERS

ITEM	ITEM NO.	DESCRIPTION	SIZE	WT (LBS)/CTN	CUBE/CTN	CASE PACK
	PFC901	Umbrella (fits 6' to 8.5' market styles)	Fits (6', 7.5', 8.5') x 62" H	45	3.3	36
	PFC902	Large Umbrella (fits 9' to 11' market styles)	Fits (9', 10', 11') x 75" H	59	3.3	36
	PFC910	X-Large Umbrella (fits rectangle up to 10'x13')	Fits (8'x10', 8'x11', 13') x 110" H	64	3.3	24
	PFC912	AG19A Cantilever style	Fits (8', 9', 10') x 90" H	77	3.3	24
	PFC955	AG25T Cantilever style	Fits (10', 11.5') x 102" H	54	3.3	24
	PFC920	AKZP Cantilever style	Fits (10', 10'x13', 11', 13') x 108" H	49	3.3	18

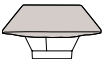
FIRE PITS, OTTOMANS & OCCASIONAL TABLES

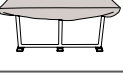
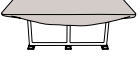
ITEM	ITEM NO.	DESCRIPTION	SIZE	WT (LBS)/CTN	CUBE/CTN	CASE PACK
	PFC805	Fits 36" to 42" Round Fire Pit/Table/Ottoman w/elastic, spring cinch lock	43" Dia. x 18" H	20	3.3	10
	PFC810	Fits 48" to 54" Round Fire Pit/Table/Ottoman w/elastic, spring cinch lock	55" Dia. x 18" H	21	3.3	8
	PFC815	Fits 19" to 26" Square Fire Pit/Table/Ottoman w/elastic, spring cinch lock	27" W x 27" D x 18" H	21	3.3	14
	PFC820	Fits 42" to 48" Square Fire Pit/Table/Ottoman w/elastic, spring cinch lock	49" W x 49" D x 18" H	22	3.3	8
	PFC825	Small Rectangle Fire Pit/Table/Ottoman w/elastic, spring cinch lock	36" W x 30" D x 18" H	32	3.3	18
	PFC830	Medium Rectangle Fire Pit/Table/Ottoman w/elastic, spring cinch lock	45" W x 30" D x 15" H	29	3.3	16
	PFC835	Large Rectangle Fire Pit/Table/Ottoman w/elastic, spring cinch lock	51" W x 31" D x 12" H	33	3.3	18
	PFC840	X-Large Rectangle Fire Pit/Table/Ottoman w/elastic, spring cinch lock	59" W x 39" D x 12" H	31	3.3	14

Key: W - Width / D - Depth / H - Height | Dia. - Diameter



DEEP SEATING						
ITEM	ITEM NO.	DESCRIPTION	SIZE	WT (LBS)/CTN	CUBE/CTN	CASE PACK
	PFC711	Lounge Chair w/elastic, spring cinch lock	33" W x 35" D x 35" H	34	3.3	14
	PFC712	Large Lounge Chair w/elastic, spring cinch lock	36" W x 40" D x 35" H	28	3.3	10
	PFC741	X-Large Lounge Chair w/elastic, spring cinch lock	43" W x 42" D x 43" H	34	3.3	10
	PFC720	Loveseat w/elastic, spring cinch lock	50" W x 35" D x 35" H	33	3.3	10
	PFC722	Large Loveseat w/elastic, spring cinch lock	60" W x 40" D x 35" H	36	3.3	10
	PFC742	X-Large Loveseat w/elastic, spring cinch lock	69" W x 42" D x 43" H	27	3.3	6
	PFC723	Sofa w/elastic, spring cinch lock	80" W x 35" D x 35" H	41	3.3	10
	PFC733	Large Sofa w/elastic, spring cinch lock	85" W x 40" D x 35" H	46	3.3	10
	PFC743	X-Large Sofa w/elastic, spring cinch lock	92" W x 42" D x 43" H	33	3.3	6
	PFC753	Curved Sofa w/elastic, spring cinch lock	102" W x 46" D x 35" H	30	3.3	6

CARE AND MAINTENANCE PRODUCTS

TG Care Collection



Our care line of products not only clean, maintain, protect and restore your outdoor furniture investment, but are also **safe for the environment**. All formulas are water-based, non-toxic, non-corrosive, and completely free of solvents (VOC's).



***MUST ORDER IN CASE PACK QUANTITIES.**

NEW LOOK! Same great formula!



Upholstery & Fabric Products*

Prolong the life of your umbrella and outdoor furniture fabric with a regular cleaning (at least once a season). After cleaning, we recommend to treat furniture fabric with our Fabric & Upholstery Protector before outdoor exposure.

Upholstery & Fabric Cleaner

- Cleaner removes dirt and restores the new look of fabrics, textiles & upholstery.
- For cushions, umbrellas, textiles, and rugs.



ITEM NO.:
TGC-UFC-32

SPECIFICATIONS:
Weight 32 oz.
Case Pk 12

Mold & Mildew Stain Remover

- Easy to use formula allows you to simply spray and rinse clean.
- Quickly dissolves mold and mildew stains.
- For cushions, umbrellas, textiles, and rugs.



ITEM NO.:
TGC-MMR-32

SPECIFICATIONS:
Weight 32 oz.
Case Pk 12

Upholstery & Fabric Protector

- Helps to prevent stains.
- Maintains the new look.
- Makes fabrics, textiles & upholstery repellent to dirt, water and moisture.
- For cushions, umbrellas, textiles, and rugs.



ITEM NO.:
TGC-UFP-32

SPECIFICATIONS:
Weight 32 oz.
Case Pk 12

Outdoor Furniture Products*

Keep your outdoor furniture looking like new – from umbrellas, dining furniture to chaise lounges.

Multi Surface Cleaner

- Removes dirt, grease, oil and pollutants from wicker, textilene, resin, polywood, and stone surfaces.



ITEM NO.:
TGC-MSC-32

SPECIFICATIONS:
Weight 32 oz.
Case Pk 12

Multi Surface Protector

- Protector contains a plasticizer substance to maintain the flexibility of the wicker resin and extends the lifetime of the furniture.
- For wicker, textilene, resin, polywood, and stone.



ITEM NO.:
TGC-WTP-32

SPECIFICATIONS:
Weight 32 oz.
Case Pk 12

Cleaner & Guard

- Fast acting and easy to use. Cleans and protects in one treatment.
- Helps to prevent and remove corrosion.
- For stainless steel, cast aluminum, and cast iron.



ITEM NO.:
TGC-MSP-16

SPECIFICATIONS:
Weight 16 oz.
Case Pk 12

Teak & Hardwoods*

Clean, restore and protect your indoor and outdoor teak & hardwood and make your furniture look fresh and new again.

Teak Cleaner & Color Restorer

- Cleans and restores discolored dark gray teak and hardwood.
- Non-hazardous.



ITEM NO.:
TGC-TWC-16

SPECIFICATIONS:
Weight 16 oz.
Case Pk 12

Teak Sealer (Brown)

- Maintain the honey-brown color of teak for a longer period of time.
- Prevents black spots.
- Non-greasy.



ITEM NO.:
TGC-TBS-16

SPECIFICATIONS:
Weight 16 oz.
Case Pk 12

Teak Protector (Transparent)

- Helps to prevent stains while keeping the natural look of the surface.
- Built-in mold and mildew inhibitor.



ITEM NO.:
TGC-TTP-16

SPECIFICATIONS:
Weight 16 oz.
Case Pk 12

Application Tools*

Eco-Friendly



Safe for the environment.

Scrubbing Pads (2 pack)

For cleaning upholstery & fabrics, teak and other outdoor furniture materials.
MADE OF 100% POLYESTER FIBERS



ITEM NO.:
TGC-SP-2PK

SPECIFICATIONS:
Weight 1 oz.
Case Pk 10

Application Cloths (3 pack)

For applying cleaner & guard, sealer and protectors.
MADE OF 80% VISCOSE
20% POLYPROPYLENE



ITEM NO.:
TGC-AC-3PK

SPECIFICATIONS:
Weight 1.5 oz.
Case Pk 12

Merchandising

Display

Showcase the TG Care - Cleaning & Maintenance products in an eye-popping branded display.

ITEM NO.:
TGC-001



Products not included.

Paint

Touch Up Paint

Our 4.5 oz. aerosol spray for hassle-free and mess-free touch up of scratches on aluminum frames and bases.

COLOR:

- Bronze
- Champagne
- Anthracite
- White
- Black
- Platinum

ITEM NO.:

- TOUCHUP-BRZ20
- TOUCHUP-CHAMP
- TOUCHUP-ANTHR
- TOUCHUP-WHT
- TOUCHUP-BLK
- TOUCHUP-5T



SPECIFICATIONS:
Weight 4.5 oz.

MERCHANDISING COLLECTION

Designer Canopy Collection

Rug Tower Display Stand

Umbrella Displays

Science Behind Shade

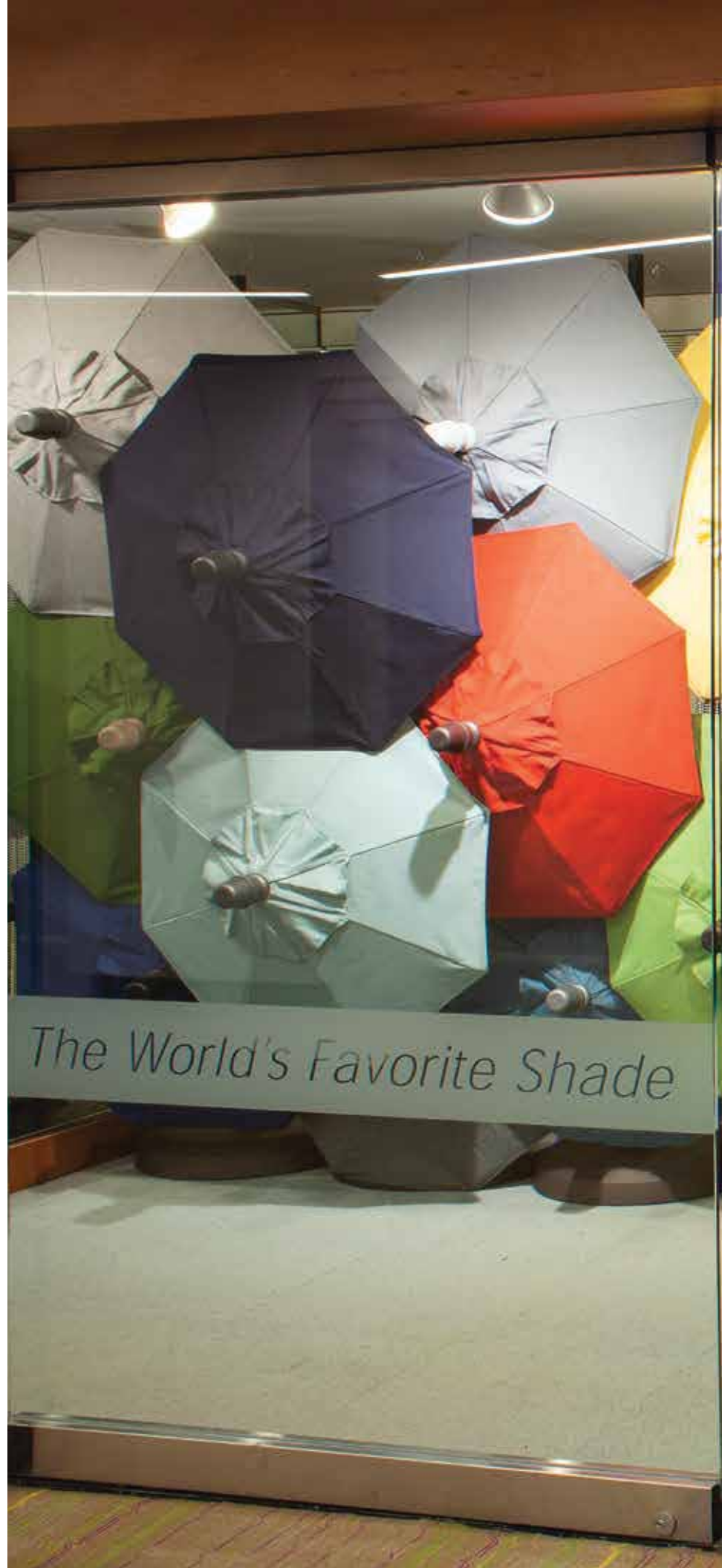



TREASURE GARDEN

DESIGNER CANOPY

Merchandising Collection

Available on 13' and 11' cantilevers & 11' and 9' market umbrellas.
Offered in 100% Solution-Dyed Acrylic and Polyester fabrics.

How to Order:

1. SELECT YOUR DC ITEM NO.

– See DC sample styles below

2. SELECT YOUR FABRIC(S)

– Go to the Treasure Garden Fabric Collection pages or refer to our Swatch Book for fabric selections.

3. SIMPLY ADD:

– The DC Item No. to your desired umbrella Item No.

Ordering Information:

To ensure the proper sewing of your custom umbrella, please list EACH individual fabric number in the sequence you wish them to appear from **top vent to trim/valance** (starting from the center finial and working towards the canopy trim/valance).

Note: You cannot mix fabric grades.

NO RETURNS ON CUSTOM OR DESIGNER CANOPY STYLE UMBRELLAS.

Double Wind Vent pricing applies to all Designer Canopy (DC) styles.

11' and 9' Market Umbrellas - Designer Canopy Designs

Item No.: DC4

Sandwich

(DWV ONLY)

Specify 2 fabrics

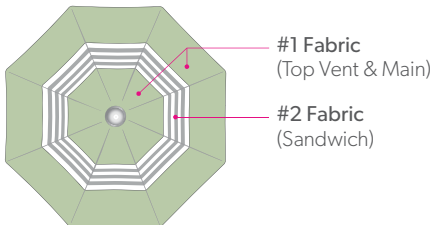

Item No.: DC5

Three Fabrics

(DWV ONLY)

Specify 3 fabrics

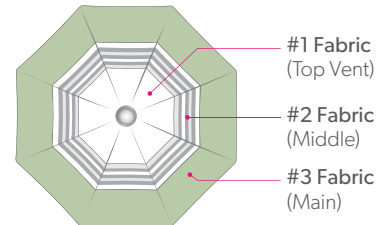

Item No.: DC6

Trim Accent

(SWV ONLY)

Specify 2 fabrics

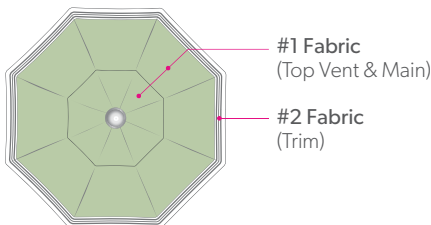

Item No.: DC7

Top Vent and Trim Accent

(SWV ONLY)

Specify 2 fabrics

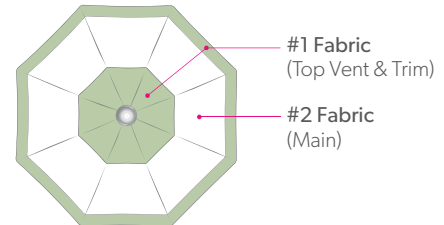

13' and 11' Cantilever Umbrellas - Designer Canopy Designs

Item No.: DC9

Top Vent and Valance Accent

Specify 2 fabrics

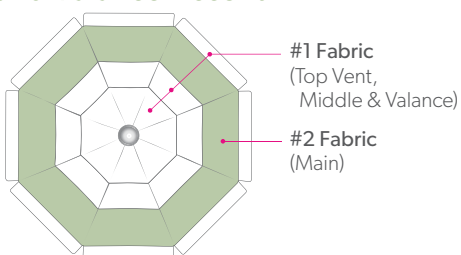

Item No.: DC11

Sandwich

Specify 2 fabrics

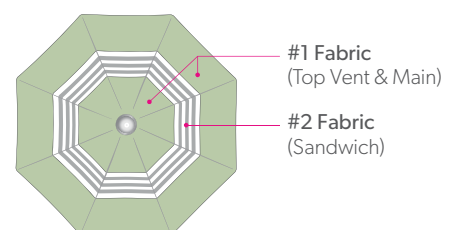

DESIGNER CANOPY

Merchandising Collection

DC's **NOT available** on AKZPRTLX, AKZPRT, AKZPSQ11, AG19A, AG25T & AG25TSQ Cantilevers, 10' Shanghai, 11' TWIST tilt, 9' TWIST tilt, 11' FLEX, 9' FLEX, 7.5' FLEX, 7.5' Glide Tilt, 7.5' Push Button Tilt, and 8'x10' Auto Tilt.



UM810-02-DC4
4813/48913

DC4



4813
Spa



48913
Vancouver
Coast Stripe



UM810-02-DC5
4804/4813/4820

DC5



4804
Eggshell



4813
Spa



4820
Boulder



UM810-02-DC6
4804/4820

DC6



4804
Eggshell



4820
Boulder



UM810-03-DC7
4813/48913

DC7



4813
Spa



48913
Vancouver
Coast Stripe



AKZP13-09-DC9
4813/48913

DC9



4813
Spa



48913
Vancouver
Coast Stripe



AKZP-09-DC11
4813/48913

DC11



4813
Spa



48913
Vancouver
Coast Stripe

RUG TOWER DISPLAY STAND

Merchandising Collection



The innovative and best way to merchandise and sell rugs!



FEATURES

- Displays up to (6) Treasure Garden Rugs
- (5) Polyurethane wheels with (1) locking wheel
- Black - powder coated steel



ITEM NO.:
RTD-09

SPECIFICATIONS

Size 25" W x 25" D x 53" H
Color Black
Weight 52 lbs.
Cube 19.05

Umbrella Display Stand

ITEM NO.:
BD609

FEATURES

- Crossbar displays (6) umbrellas

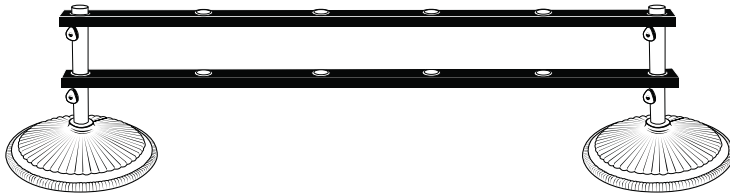

Crossbars install onto Treasure Garden's BA509, BG509, BW509 and BKM1009 black bases (Sold separately).

SPECIFICATIONS

Size	72" W x 3" D (2) Crossbars
Color	Black
Weight	25 lbs.
Cube	0.81

Mini Umbrella Display

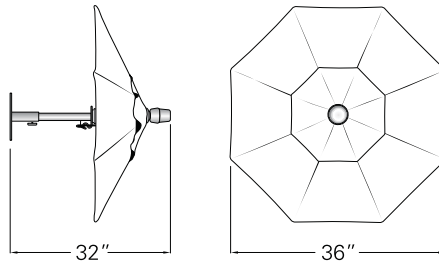

SPECIFICATIONS

Umbrella Size	36"
Height	32"
Shape	Octagon
Wall Bracket	Included
Weight	9 lbs.
Cube	0.65
Carton Size	28" x 7" x 7"



Single Fabric Display:

Includes canopy, frame/finial and wall bracket.

Example: 4801 Cobalt **Item No.:** UMINI-QS/4801

ITEM NO.:

UMINI-QS/_____ Fabric No.

CANOPY ONLY Single Fabric:

Example: 4801 Cobalt **Item No.:** CMINI/4801

CMINI/_____ Fabric No.



Designer Canopy Fabric Display:

Includes Designer Canopy, frame/finial and wall bracket.

Example: DC5 - 4801 Cobalt/4853 Vanilla/4820 Boulder

Item No.: UMINI-QS-DC5/4801/4853/4820

UMINI-QS-DC___/___/___/___ DC# Fabric Nos.

CANOPY ONLY Designer Canopy Fabric:

Example: DC5 - 4801 Cobalt/4853 Vanilla/4820 Boulder

Item No.: CMINI-DC5/4801/4853/4820

CMINI-DC___/___/___/___ DC# Fabric Nos.

SCIENCE BEHIND SHADE

Merchandising Collection

Solar radiation can dramatically change the temperatures of an object that it hits, heating it far above the actual air temperature. The proper shade over your dining or deep seating areas can reduce the temperature up to **20%**.







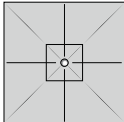
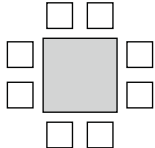
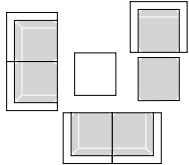
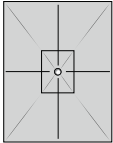
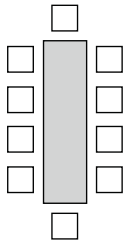
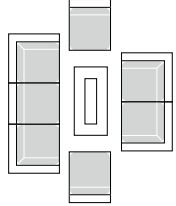
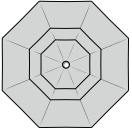
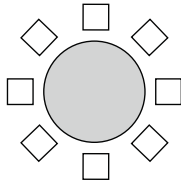
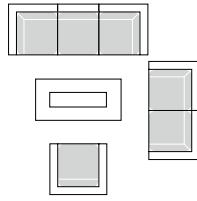
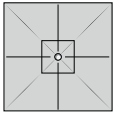
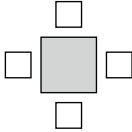
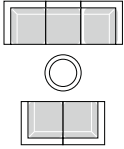
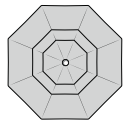
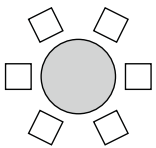
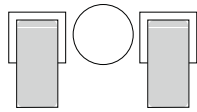

NOTE:

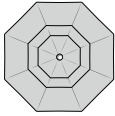
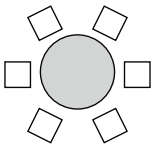
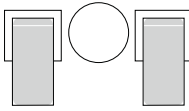
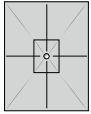
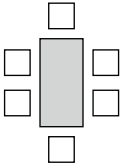
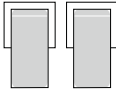
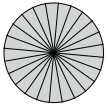
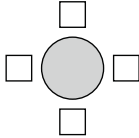
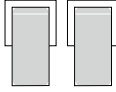
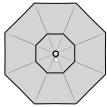
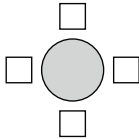
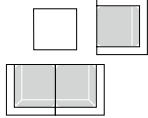
□ Suggested RUG size

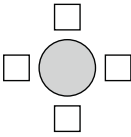
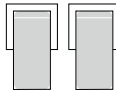
■ Suggested TABLE size

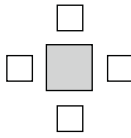
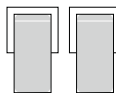
A **sweltering 95°** can become a **comfortable 80°** with proper shade!

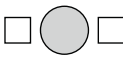
SIZE/SHAPE	DINING	DEEP SEATING*	STYLE
<p>11.5' Square</p>  <p>132 sq. ft. coverage</p>	<p>■ 60" to 84" square table</p> 		<p>11.5' AKZ Plus Cantilever</p> <p>□ 7'10" x 10' Rug</p>
<p>10'x13' Rectangle</p>  <p>130 sq. ft. coverage</p>	<p>■ 84" to 108" rectangle table</p> 		<p>10'x13' Starlux AKZ Plus Cantilever</p> <p>10'x13' AKZ Plus Cantilever</p> <p>□ 7'10" x 10' Rug</p>
<p>13' Octagon</p>  <p>129 sq. ft. coverage</p>	<p>■ 70"+ round table</p> 		<p>13' Starlux AKZ Plus Cantilever</p> <p>13' AKZ Plus Cantilever</p> <p>□ 7'10" x 10' Rug</p>
<p>10' Square</p>  <p>100 sq. ft. coverage</p>	<p>■ 48" to 54" square table</p> 		<p>10' AG25TSQ Cantilever</p> <p>□ 7'10" x 10' Rug</p>
<p>11.5' Octagon</p>  <p>96 sq. ft. coverage</p>	<p>■ 60"+ round table</p> 		<p>11.5' AG25T Cantilever</p> <p>□ 7'10" x 10' Rug</p>

SIZE/SHAPE	DINING	DEEP SEATING*	STYLE
11' Octagon  85 <i>sq. ft. coverage</i>	<ul style="list-style-type: none"> 60"+ round table 		11' AKZ Plus Cantilever 11' TWIST <i>tilt</i> 11' Collar Tilt 11' FLEX 11' Auto Tilt □ 7'10" x 10' Rug
8'x10' Rectangle  80 <i>sq. ft. coverage</i>	<ul style="list-style-type: none"> 60" to 72" rectangle table 		8'x10' Auto Tilt □ 7'10" x 10' Rug
10' Round  70 <i>sq. ft. coverage</i>	<ul style="list-style-type: none"> 48" to 54" round table 		10' Shanghai Collar Tilt □ 5'3" x 7'4" Rug
10' Octagon  70 <i>sq. ft. coverage</i>	<ul style="list-style-type: none"> 48" to 54" round table 		10' AG19A Cantilever □ 7'10" x 10' Rug
9' Octagon  57 <i>sq. ft. coverage</i>	<ul style="list-style-type: none"> 48" to 54" round table 		9' TWIST <i>tilt</i> 9' Starlux Collar Tilt 9' Collar Tilt 9' FLEX 9' Auto Tilt 9' Glide Tilt 9' Push Button Tilt 9' Quad Pulley Lift □ 5'3" x 7'4" Rug □ 7'10" x 10' Rug
7.5' Square  56 <i>sq. ft. coverage</i>	<ul style="list-style-type: none"> 48" to 54" square table 		7.5' FLEX □ 5'3" x 7'4" Rug
7.5' Octagon  39 <i>sq. ft. coverage</i>	<ul style="list-style-type: none"> 30" to 36" cafe/bistro 		7.5' Glide Tilt 7.5' Push Button Tilt □ 5'3" x 7'4" Rug

*Suggested Deep Seating arrangements can vary based on actual individual piece dimensions.



Sales Programs

TG Custom -
Domestic Custom-Made Umbrellas

TG Direct -
Direct Container Program

TGEx Program -
Quick-Ship Program

CQS Program -
Cantilever Quick-Ship Program

The **TG CUSTOM Program** features the finest residential and commercial umbrellas from Treasure Garden, Shademaker and Jardinico. We offer your choice of hundreds of quality fabrics from the top U.S. mills; as well as our exclusive **obraviva** fabrics. All umbrella frames/finishes & accessories featured in the 2025 catalog are available to ship from Baldwin Park, CA.

DOMESTIC CUSTOM-MADE UMBRELLAS

Create extraordinary umbrellas with thousands of possible fabric combinations for 2025; the program includes our exclusive **Designer Canopy Collection** at the standard DWV price.

In-Stock Fabrics:

Lead time is 3 weeks for Treasure Garden, Shademaker and Jardinico from Baldwin Park, CA. Please note that this lead time is based on capacity and material availability and is subject to change throughout the season.

Non-Stock Fabrics:

Lead time is 5 weeks for Treasure Garden and Shademaker and 8-10 weeks for Jardinico from Baldwin Park, CA. Please note that this lead time is based on capacity and material availability and is subject to change throughout the season. Certain mills may have a minimum yardage requirement.

Full Roll & Less Than a Full Roll:

Furniture Grade A - 20% upcharge.

Furniture Grade A+ and Awning Grade - 30% upcharge.

Customer's Own Material (COM):

Grade C pricing + 15%.

All Non-Stock Striped Fabrics:

Need to be ordered in **pairs**, due to cutting requirements.

Contact your Customer Service Representative for availability and specific lead times.

FABRICS BY THE YARD

GRADE

A

MAXIMUM QUANTITY: 10 yards



Our **DIRECT Container Program** simplifies the process of shipping large quantities of goods anywhere. Give us your quantity breakdown and final destination point, we'll take care of the rest.

DIRECT CONTAINER PROGRAM

Direct Container Order Guidelines:

All TG 2025 program frame colors combined with TGD fabrics are available to ship from Ningbo, China.

Chinese New Year: January 29, 2025

Chinese New Year holiday is January 27 - February 3, 2025. Last day before CNY shipment is January 17, 2025 and the 1st week of shipment after CNY is week of February 27, 2025.

Market Conditions can affect production lead times as well as shipment dates. We will make every effort to ship containers as requested however all containers will be scheduled on a first come/first serve basis. Our import office will alert you as soon as possible as to your scheduled shipment date(s).

Production Lead Time:

Allow 12-16 weeks*. Contact your TG Sales or Customer Service Representative for orders requiring shorter lead times. May change depending on port and rail congestion situation.

Transit Time:

Allow 6-10 weeks* depending on current market conditions. Containers can arrive as fast as 4 weeks to the West Coast and take up to 10 weeks to the East Coast.

*Please note that this lead time is based on capacity and material availability and is subject to change throughout the season.

Payment Terms:

- Irrevocable At Sight Letter of Credit at order acknowledgment or
- Wire transfer 21 days prior to scheduled ship date

FOB:

All container orders from Ningbo, China ship Freight Collect. The dealer is responsible for all freight charges - both sea and land, insurance fees, broker fees, bank fees for L/C or wire transfers and additional handling fees.

Freight Forwarder:

- You may select your own or we will use ours.
- If selecting your own – must provide forwarders name & contact information.

Bill Of Lading:

- Must choose Original or Telex Release
- If Telex Release is chosen, a payment must be made at the time it's requested to avoid any delays.

PLEASE NOTE YOUR CHOICES ON YOUR ORDER.

The purchase of a container may also involve bank charges and other charges unrelated to the price of the product including but not limited to duties, storage, shipping and transportation charges, third party inspection charges whether inspected at point of origin, point of entry or point of delivery.

*Contact your TG Sales or Customer Service Representative for any questions regarding specific lead times.

TG DIRECT - DUTY SCHEDULE

Complete Umbrellas	6.975%
Umbrella Bases	5.675%
Protective Covers	7.475% (+7.5% on List 4A)
Umbrella Frames only	12.475%
Umbrella Lights	4.375% (+25% - Tariff 301)

Duty:

All products manufactured by Treasure Garden Inc., incur duties to the USA. This is a tax imposed by our Federal government. Unfortunately, we are not duty free.

Dealer is responsible for all duties for container goods before container arrives at destination.

Estimated overall Freight & Duties:

(14-25%) Depending on your location and product assortment. Subject to change based on ocean freight fluctuations.

In-Season Order Guidelines:

All frame colors combined with TGD fabrics are available to ship from Ningbo, China.

In-Season Production Lead Time:

Allow 8-12 weeks*. However, we may be able to ship faster depending on capacity.

Note: Special order frame/base colors will require longer lead times.

In-Season Transit Time:

Allow 4-7 weeks*. Containers can arrive as fast as 3 weeks to the West Coast and take as long as 6 weeks to the East Coast.

Note: The Direct Container Program is not available for In-season reorder from Baldwin Park, CA. It is imperative to forecast your entire seasons needs on your container order for any special frame styles.

Replacement Parts: We DO NOT stock replacement parts for items that are TG Direct Only. If you are ordering TG Direct Only items, **we recommend ordering additional replacement parts with your container order.** Your TG Sales or Customer Service Representative can assist you with suggestions on how to place an order.



TGEx "Quick-Ship" program is available in select awning grade fabrics on our Shademaker 8 ft Libra styles and select furniture grade on our 7.5' and 9' Single Wind Vent (SWV) & 11' Double Wind Vent (DWW) Treasure Garden market umbrellas (11' TWIST tilt available in Single Wind Vent only).

NOTE: DO NOT COMBINE NON-TGEx fabrics on your TGEx order. For all other fabrics available (NON-TGEx), see pages 42-45.

Program is available year-round & ships within **2 BUSINESS DAYS***

*NOTE: Shipping may be delayed due to possible fabric shortage or carrier.

LIBRA

8 ft | 2.5 m LIB-25 Octagon
8 ft | 2.5 m LIB-25S Square
 (see page 97)

See pages 116-118 for Libra base/mount options.
 (sold separately)

VALANCE OPTION NOT AVAILABLE.

sunbrella Awning Grade 100% Solution-Dyed Acrylic

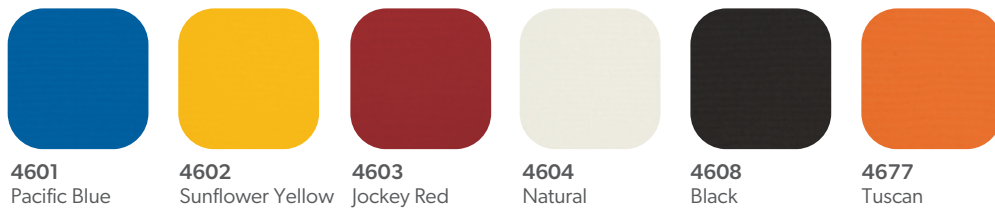

4601 Pacific Blue 4602 Sunflower Yellow 4603 Jockey Red 4604 Natural 4608 Black 4677 Tuscan



Available frame finish:



SS Silver Shadow SG Shadow Graphite

MARKET UMBRELLAS

sunbrella Grade A 100% Solution-Dyed Acrylic



5401 Pacific Blue 5403 Jockey Red 5404 Natural 5407 Henna 5408 Black 5413 Spa 5422 Antique Beige 5439 Navy
 5446 Forest Green 5453 Canvas 5476 Heather Beige 40433 Cast Silver 48080 Spectrum Indigo

obravia Grade C 100% Solution-Dyed Polyester

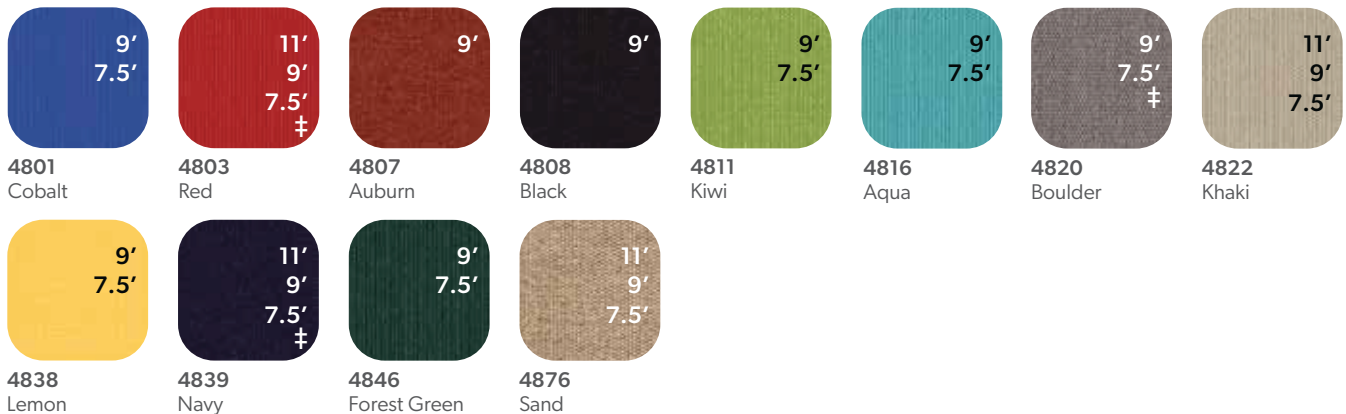

4801 Cobalt 4803 Red 4807 Auburn 4808 Black 4811 Kiwi 4816 Aqua 4820 Boulder 4822 Khaki
 4838 Lemon 4839 Navy 4846 Forest Green 4876 Sand

‡ Available TGEx fabric for 11' and 9' TWIST tilt style.

ACCESSORIES



The TGEEx "Quick-Ship" Program also includes the following accessories:

- Outdoor rugs
- Treasure Garden, Shademaker and Jardinico umbrella bases & mount kits
- Umbrella lights
- Protective furniture covers
- Care and maintenance products
- Replacement canopies within TGEEx and CQS programs
- Jardinico accessories



NOTE: Dealers who place a single purchase order without specifying a specific program, the order will automatically be shipped out at the longer lead time based on the items ordered. Dealers who want separate shipments with different lead times (i.e. – TGEEx and TGCustom), please write separate purchase orders per program and make sure correct items are offered in those programs. Dealers who place a single purchase order specifying multiple or incorrect programs based on items ordered, the order will automatically be split-shipped separately according to their respective programs.

Program is available year-round & ships within 5 BUSINESS DAYS*

**NOTE: Shipping may be delayed due to possible fabric shortage or carrier.*

CANTILEVERS

AKZ Plus Cantilevers:

13' AKZP13 (see page 8)

10'x13' AKZPRT (see page 9)

11' AKZP (see page 11)

Available frame finish:

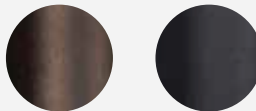

00
Bronze

09
Black

See pages 18-19 for cantilever base/mount options.
(sold separately)

VALANCE OPTION NOT AVAILABLE.



13' AKZP13



10'x13' AKZPRT



11' AKZP

NOTE: To ensure your cantilever "Quick-Ship" order is processed without delay. Orders must be placed on a **separate P.O.** and marked "Cantilever Quick-Ship".



Grade A

100% Solution-Dyed
Acrylic



5403
Jockey Red



5404
Natural



5408
Black

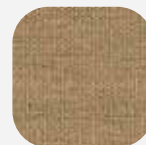

5476
Heather Beige



40433
Cast Silver



48080
Spectrum Indigo



Grade C

100% Solution-Dyed
Polyester



4820
Boulder

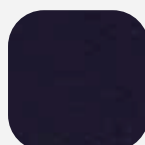

4839
Navy



4876
Sand

All fabrics shown are not to scale. Patterns, textures and colors may vary slightly from actual fabric; please refer to the Treasure Garden fabric swatch book for samples.

TABLE OF CONTENTS

AQUARIUS CENTER POST 7.5 ft 2.3 m Octagon 7.5 ft 2.3 m Square 9 ft 2.7 m Octagon	94-95
LIBRA CENTER POST 6.5 ft 2.0 m Square 8 ft 2.5 m Octagon 8 ft 2.5 m Square 9 ft 2.7 m Octagon 9 ft 2.7 m Square	96-97
ATLAS CENTER POST 10 ft 3.0 m Octagon 10 ft 3.0 m Square 11.5 ft 3.5 m Square 13 ft 4.0 m Octagon	98-99
ASTRAL CENTER POST 13 ft 4.0 m Square 16.5 ft 5.0 m Octagon 16.5 ft 5.0 m Square	100-101
NEW TAURUS SIDE POST 10 ft 3.0 m Octagon 10 ft 3.0 m Square	102-103
SOLARIS SIDE POST 9 ft 2.7 m Square 10 ft 3.0 m Octagon 10 ft 3.0 m Square 11.5 ft 3.5 m Octagon	104-105
NEW SOLARIS LX SIDE POST 10 ft 3.0 m Square	106-107
POLARIS SIDE POST 11.5 ft 3.5 m Square 10 x 13 ft 3.0 x 4.0 m Rectangle 13 ft 4.0 m Octagon 13 ft 4.0 m Square	108-109
NEW POLARIS LX SIDE POST 13 ft 4.0 m Square	110-111
ORION SIDE POST 10 ft 3.0 m Octagon 10 ft 3.0 m Square 13 ft 4.0 m Octagon	112-113
NEW GEMINI DUAL SIDE POST 10 ft 3.0 m Square	114-115
NEW BASES & MOUNT OPTIONS	116-118
BASE WEIGHT MATRIX	119
REPLACEMENT PARTS & OPTIONS	120
NEW FRAME FINISHES	121
FABRICS	122-123
TERMS & CONDITIONS	140-142
WARRANTY / GUARANTEE	144





SHADEMAKER
architectural shade



SHOWN | **AQU-27-SS** in 5402 Granite

AQUARIUS



ITEM NO.	SHAPE	SIZE	OPEN HEIGHT	COVERAGE	RIBS	MINIMUM BASE WEIGHT	FINISH
AQU-23	Octagon	7.5 ft 2.3 m	7' 8" ft 2.3 m	39 sq ft	8	100 lbs	SS
AQU-23S	Square	7.5 ft 2.3 m	7' 8" ft 2.3 m	51 sq ft	8	100 lbs	SS
AQU-27	Octagon	9 ft 2.7 m	7' 11" ft 2.4 m	60 sq ft	8	100 lbs	SS, SG 

- Commercial grade fiberglass ribs
- Easy push-up automatic locking system
- Commercial strength nylon hub and fittings
- Commercial grade canopy fasteners adding durability and design
- Ideal for a wide range of applications, including ocean and pool side environments
- Includes high performance protective cover

NOTE: Recommended minimum weight requirements for free-standing applications.

FRAME FINISH OPTIONS:

See page **121**

BASES & MOUNT OPTIONS:

See page **116-118**

Standard Lead Time

Shipping Information: **Truck Only**

NOTE: Oversized - Additional shipping cost for this style.

Visit www.shademaker.com for more product information.





SHOWN | LIB-27S-SS in 14106 Seasalt

LIBRA



* **TGEx**
GUIDANCE PROGRAM
(see pg. 90)

ITEM NO.	SHAPE	SIZE	OPEN HEIGHT	COVERAGE	RIBS	MINIMUM BASE WEIGHT	FINISH
LIB-20S	Square	6.5 ft 2.0 m	7' 6" ft 2.3 m	43 sq ft	4	100 lbs	SS
LIB-25*	Octagon	8 ft 2.5 m	7' 6" ft 2.3 m	52 sq ft	8	100 lbs	SS, SG, AW,  WO 
LIB-25S*	Square	8 ft 2.5 m	7' 6" ft 2.3 m	67 sq ft	8	100 lbs	SS, SG, AB, AW, WO 
LIB-27*	Octagon	9 ft 2.7 m	7' 7" ft 2.3 m	60 sq ft	8	120 lbs	SS
LIB-27S*	Square	9 ft 2.7 m	7' 7" ft 2.3 m	77 sq ft	8	120 lbs	SS, SG

- Easy push-up automatic locking system
- Internal counterweight to close with ease
- Telescoping mast*
- Modernly designed aluminum hub and fittings
- Commercial grade canopy fasteners adding durability and design
- Includes high performance protective cover

NOTE: Recommended minimum weight requirements for free-standing applications.

FRAME FINISH OPTIONS:

See page **121**

BASES & MOUNT OPTIONS:

See page **116-118**

Standard Lead Time

Shipping Information: **Truck Only**

NOTE: Oversized - Additional shipping cost for this style.

Visit www.shademaker.com for more product information.



SHOWN | **ATL-30S-SS** in 5404 Natural

ATLAS



ITEM NO.	SHAPE	SIZE	OPEN HEIGHT	COVERAGE	RIBS	MINIMUM BASE WEIGHT	FINISH
ATL-30	Octagon	10 ft 3.0 m	8' 6" ft 2.6 m	75 sq ft	8	300 lbs	SS
ATL-30S	Square	10 ft 3.0 m	8' 6" ft 2.6 m	100 sq ft	8	300 lbs	SS, SG
ATL-35S	Square	11.5 ft 3.5 m	8' 10" ft 2.7 m	131 sq ft	8	300 lbs	SS, SG, AB
ATL-40	Octagon	13 ft 4.0 m	8' 10" ft 2.7 m	134 sq ft	8	400 lbs	SS

- Telescoping mast
- Quick and effortless crank lift system
- Modernly designed aluminum hub and fittings
- Commercial grade canopy fasteners adding durability and design
- Removable crank handle
- Galvanized internal mast stem
- Includes aluminum mast stem cover
- Includes high performance protective cover

NOTE: Recommended minimum weight requirements for free-standing applications.

FRAME FINISH OPTIONS:

See page **121**

BASES & MOUNT OPTIONS:

See page **118**

Standard Lead Time

Shipping Information: **Truck Only**

Visit www.shademaker.com for more product information.



SHOWN | **AST-50-SS** in 5404 Natural

ASTRAL



ITEM NO.	SHAPE	SIZE	OPEN HEIGHT	COVERAGE	RIBS	MINIMUM BASE WEIGHT	FINISH
AST-40S	Square	13 ft 4.0 m	9' 1" ft 2.8 m	172 sq ft	8	500 lbs	SS, SG, AB, AW
AST-50	Octagon	16.5 ft 5.0 m	9' 1" ft 2.8 m	210 sq ft	8	600 lbs*	SS, SG, AB, AW
AST-50S	Square	16.5 ft 5.0 m	9' 1" ft 2.8 m	266 sq ft	8	700 lbs*	SS, SG, AB, AW

- Telescoping mast
- Quick and effortless crank lift system
- Modernly designed aluminum hub and fittings
- Commercial grade canopy fasteners adding durability and design
- Removable crank handle
- Galvanized internal mast stem
- Includes aluminum mast stem cover
- Includes high performance protective cover

NOTE: Recommended minimum weight requirements for free-standing applications.

***Permanent mount recommended.**

FRAME FINISH OPTIONS:

See page **121**

BASES & MOUNT OPTIONS:

See page **118**

Check for Lead Time

Shipping Information: **Truck Only**

Visit www.shademaker.com for more product information.



SHOWN | **TAU-30S-SS** in 5404 Natural



ITEM NO.	SHAPE	SIZE	OVERALL HEIGHT	COVERAGE	RIBS	MINIMUM BASE WEIGHT	FINISH
TAU-30	Octagon	10 ft 3.0 m	8' 3" ft 2.5 m	75 sq ft	8	300 lbs	SS, SG
TAU-30S	Square	10 ft 3.0 m	8' 3" ft 2.5 m	100 sq ft	8	300 lbs	SS, SG

- Quick & easy open and close system with gas piston assist
- 360° rotation with 8 locking positions
- Modernly designed aluminum hub and fittings
- Commercial grade canopy fasteners adding durability and design
- Galvanized internal mast stem
- Includes aluminum mast stem cover
- Includes high performance protective cover

NOTE: Recommended minimum weight requirements for free-standing applications.

FRAME FINISH OPTIONS:

See page **121**

BASES & MOUNT OPTIONS:

See page **118**

Standard Lead Time

Shipping Information: **Truck Only**



Visit www.shademaker.com for more product information.



SHOWN | **SOL-27S-SS** in 5404 Natural

SOLARIS



ITEM NO.	SHAPE	SIZE	OVERALL HEIGHT	COVERAGE	RIBS	MINIMUM BASE WEIGHT	FINISH
SOL-27S	Square	9 ft 2.7 m	8' 9" ft 2.7 m	77 sq ft	8	300 lbs	SS, SG
SOL-30	Octagon	10 ft 3.0 m	8' 9" ft 2.7 m	75 sq ft	8	300 lbs	SG, AB, AW, WO 
SOL-30S	Square	10 ft 3.0 m	8' 9" ft 2.7 m	100 sq ft	8	350 lbs	SS, SG, AB, AW, WO 
SOL-35	Octagon	11.5 ft 3.5 m	8' 9" ft 2.7 m	103 sq ft	8	400 lbs	SS

- Simple to operate infinite front to back tilt system
- 360° rotation with 8 locking positions
- Removable crank handle
- Modernly designed aluminum hub and fittings
- Commercial grade canopy fasteners adding durability and design
- Galvanized internal mast stem
- Includes aluminum mast stem cover
- Includes high performance protective cover

NOTE: Recommended minimum weight requirements for free-standing applications.

FRAME FINISH OPTIONS:

See page **121**

BASES & MOUNT OPTIONS:

See page **118**

Standard Lead Time

Shipping Information: **Truck Only**

Visit www.shademaker.com for more product information.



SHOWN | **SOLLX-30S-SS** in 14106 Seasalt

NEW SOLARIS LX



ITEM NO.	SHAPE	SIZE	OVERALL HEIGHT	COVERAGE	RIBS	MINIMUM BASE WEIGHT	FINISH
SOLLX-30S	Square	10 ft 3.0 m	8' 9" ft 2.7 m	100 sq ft	8	350 lbs	SS, SG

- Create an elegant and modern ambiance with upward warm lighting
- External rechargeable battery pack with charge level indicator
- Control light features with remote control
- Unlimited light syncing capability allowing you to control multiple Shademaker umbrella lights using a single remote control
- Enjoy up to 6-8 hours of battery life
- Easy to operate infinite front-to-back tilt system
- 360° rotation with 8 locking positions
- Removable crank handle
- Modernly designed aluminum hub and fittings
- Commercial grade canopy fasteners adding durability and design
- Galvanized internal mast stem
- Includes aluminum mast stem cover
- Includes high performance protective cover

NOTE: Recommended minimum weight requirements for free-standing applications.

FRAME FINISH OPTIONS:

See page 121

BASES & MOUNT OPTIONS:

See page 118

Standard Lead Time

Shipping Information: **Truck Only**



Visit www.shademaker.com for more product information.



SHOWN | **POL-40-AB** in 40428 Cast Ash

POLARIS



ITEM NO.	SHAPE	SIZE	OVERALL HEIGHT	COVERAGE	RIBS	MINIMUM BASE WEIGHT	FINISH
POL-35S	Square	11.5 ft 3.5 m	9' 6" ft 2.9 m	131 sq ft	8	550 lbs	SS, SG, AW
POL-340RT	Rectangle	10 x 13 ft 3.0 x 4.0 m	9' 6" ft 2.9 m	130 sq ft	8	550 lbs	SS, SG, AB, AW
POL-40	Octagon	13 ft 4.0 m	9' 6" ft 2.9 m	134 sq ft	8	700 lbs	SG, AB
POL-40S	Square	13 ft 4.0 m	9' 6" ft 2.9 m	172 sq ft	8	700 lbs	SS, SG, AB

- Simple to operate infinite front to back tilt system
- 360° rotation with 8 locking positions
- Removable crank handle
- Modernly designed aluminum hub and fittings
- Commercial grade canopy fasteners adding durability and design
- Galvanized internal mast stem
- Includes aluminum mast stem cover
- Includes high performance protective cover

NOTE: Recommended minimum weight requirements for free-standing applications.

FRAME FINISH OPTIONS:

See page **121**

BASES & MOUNT OPTIONS:

See page **118**

Standard Lead Time

Shipping Information: **Truck Only**

NOTE: Striped fabrics not available on POL-340RT

Visit www.shademaker.com for more product information.



SHOWN | **POLLX-40S-SS** in 5404 Natural

NEW POLARIS LX



ITEM NO.	SHAPE	SIZE	OVERALL HEIGHT	COVERAGE	RIBS	MINIMUM BASE WEIGHT	FINISH
POLLX-40S	Square	13 ft 4.0 m	9' 6" ft 2.9 m	172 sq ft	8	700 lbs	SS, SG

- Create an elegant and modern ambiance with upward warm lighting
- External rechargeable battery pack with charge level indicator
- Control light features with remote control
- Unlimited light syncing capability allowing you to control multiple Shademaker umbrella lights using a single remote control
- Enjoy up to 6-8 hours of battery life
- Easy to operate infinite front-to-back tilt system
- 360° rotation with 8 locking positions
- Removable crank handle
- Modernly designed aluminum hub and fittings
- Commercial grade canopy fasteners adding durability and design
- Galvanized internal mast stem
- Includes aluminum mast stem cover
- Includes high performance protective cover

NOTE: Recommended minimum weight requirements for free-standing applications.

FRAME FINISH OPTIONS:

See page 121

BASES & MOUNT OPTIONS:

See page 118

Standard Lead Time

Shipping Information: **Truck Only**



Visit www.shademaker.com for more product information.



SHOWN | **ORI-30-SS** in 40456 Cast Lagoon

ORION



ITEM NO.	SHAPE	SIZE	OVERALL HEIGHT	COVERAGE	RIBS	MINIMUM BASE WEIGHT	FINISH
ORI-30	Octagon	10 ft 3.0 m	8' 10" ft 2.7 m	75 sq ft	8	300 lbs	SS
ORI-30S	Square	10 ft 3.0 m	8' 10" ft 2.7 m	100 sq ft	8	350 lbs	SS, SG
ORI-40	Octagon	13 ft 4.0 m	9' ft 2.7 m	134 sq ft	8	500 lbs	SS, SG, AB

- Canopy structure easily detaches for storage
- 360° rotation with 8 locking positions
- Simple to operate crank lift system
- Removable crank handle
- Commercial grade stainless steel cable
- Modernly designed aluminum hub and fittings
- Commercial grade canopy fasteners adding durability and design
- Galvanized internal mast stem
- Includes aluminum mast stem cover
- Includes high performance protective cover

NOTE: Recommended minimum weight requirements for free-standing applications.

FRAME FINISH OPTIONS:

See page **121**

BASES & MOUNT OPTIONS:

See page **118**

Standard Lead Time

Shipping Information: **Truck Only**

Visit www.shademaker.com for more product information.



SHOWN | **GEM-30S-SS** in 40434 Cast Slate

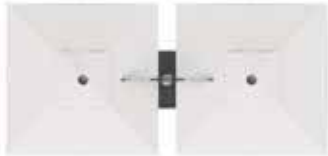

ITEM NO.	SHAPE	SIZE	OVERALL HEIGHT	COVERAGE	RIBS	MINIMUM BASE WEIGHT	FINISH
----------	-------	------	----------------	----------	------	---------------------	--------

GEM-30S	Square	10 ft 3.0 m	8' 3" ft 2.5 m	200 sq ft	8	400 lbs	SS
----------------	--------	---------------	------------------	-----------	---	---------	----

- Double-sided canopy umbrella
- 360° rotation with 8 locking positions
- Quick & easy open and close system with gas piston assist
- Modernly designed aluminum hub and fittings
- Commercial grade canopy fasteners adding durability and design
- Galvanized internal mast stem
- Includes aluminum mast stem cover
- Includes high performance protective cover

NOTE: Recommended minimum weight requirements for free-standing applications.

FRAME FINISH OPTIONS:

See page **121**

BASES & MOUNT OPTIONS:

See page **118**

Standard Lead Time
Shipping Information: **Truck Only**

Visit www.shademaker.com for more product information.

BASES & WEIGHTS

for **AQUARIUS & LIBRA**

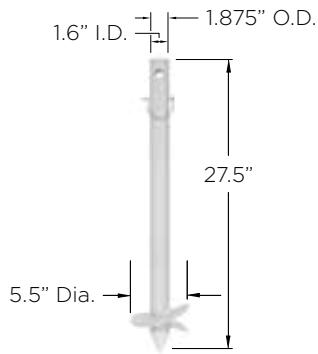

SAND ANCHOR	FINISH	WEIGHT	SIZE	THICKNESS	CUBE
SM-ANCHOR-5T	Platinum	2.3 lbs	27.5"	5.5"	1.6



EXTERNAL STEM	FINISH	WEIGHT	CUBE
MKSB21-SG	Shadow Graphite	5.4 lbs	0.72
MKSB21-AB	Architectural Bronze	5.4 lbs	0.72
MKSB21-AW	Arctic White	5.4 lbs	0.72
 MKSB21-SD	Sand	5.4 lbs	0.72

Note: Required for Z-Plate and Mount Kits.

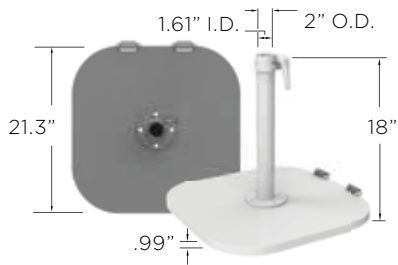

ASPEN	FINISH	WEIGHT	CUBE	PALLET
BSA120SQ-SG	Shadow Graphite	120 lbs	3	16
BSA120SQ-AW	Arctic White	120 lbs	3	16

Steel square base with wheels.

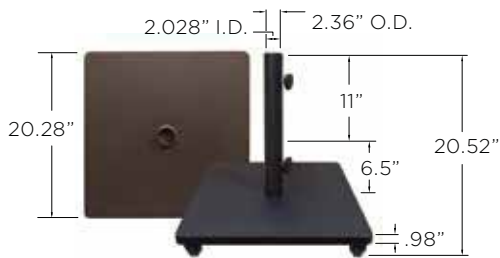

STEEL BASE	FINISH	WEIGHT	CUBE	PALLET
BSK1200	Bronze	120 lbs	1.72	16
BSK1209	Black	120 lbs	1.72	16

Steel square base with casters.



COMMERCIAL	FINISH	WEIGHT	CUBE	PALLET
BA1500	Bronze	150 lbs	2.85	12
BA1509	Black	150 lbs	2.85	12

Cast aluminum round base.

BASES & WEIGHTS

for **AQUARIUS & LIBRA**

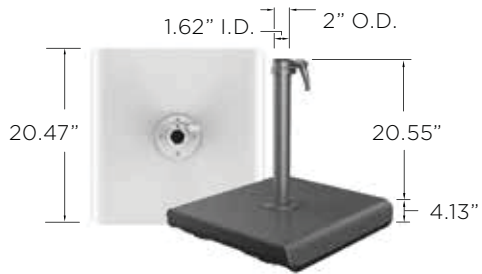

ATHENS	FINISH	WEIGHT	CUBE	PALLET
BTT100-SG	Shadow Graphite	108 lbs	3.5	14
BTT100-AW	Arctic White	108 lbs	3.5	14

Cast aluminum square base with wheels.

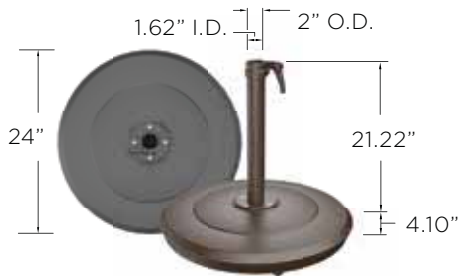

AURORA	FINISH	WEIGHT	CUBE	PALLET
BRW100-SG	Shadow Graphite	100 lbs	3.53	14
BRW100-AB	Architectural Bronze	100 lbs	3.53	14
BRW100-AW	Arctic White	100 lbs	3.53	14
BRW100-5T	Platinum	100 lbs	3.53	14
BRW100-SD	Sand	100 lbs	3.53	14

Cast aluminum round base with wheels.

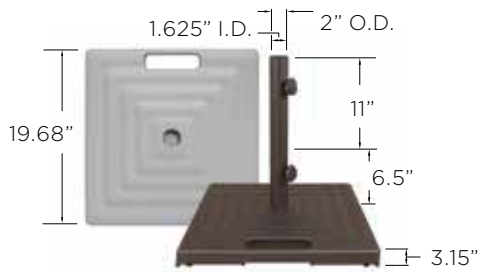

MONACO	FINISH	WEIGHT	CUBE	PALLET
BKMSQ1000	Bronze	100 lbs	1.8	24
BKMSQ1003	White	100 lbs	1.8	24
BKMSQ1009	Black	100 lbs	1.8	24

Cast aluminum square base with wheels and handle.



MONACO	FINISH	WEIGHT	CUBE	PALLET
BKM1000	Bronze	100 lbs	2.3	24
BKM1003	White	100 lbs	2.3	24
BKM1009	Black	100 lbs	2.3	24

Cast aluminum round base with wheels and handle.

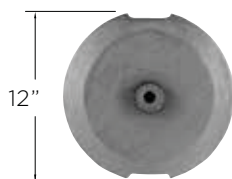

ADD-ON WEIGHT	WEIGHT
BW30	30 lbs

Optional cast iron weight adds 30 lbs to our Athens, Aurora, and Monaco bases.

BASES & MOUNT OPTIONS

for ALL STYLES



NEW Z-PLATE	WEIGHT	FINISH	SIZE	THICKNESS	CUBE
ZB115	115 lbs	SG, AB, AW, SD	26"	.63"	1.29
ZB225	225 lbs	SG, AB, AW, SD	36"	.63"	2.89

Note: External Stem required for Aquarius & Libra styles (sold separately)



ADD-ON WHEELS	COMPATIBLE WITH	WEIGHT	CUBE
ZBWH-SM	ZB115	1.2 lbs	.04
ZBWH-LG	ZB225	6.61 lbs	1.48

Set of 4 locking wheels



TITAN BASE	WEIGHT	TOTAL WEIGHT W/ PAVERS*	FINISH	SIZE	CUBE
BGT850	118.1 lbs	850 lbs	SG, AB, AW	40.5" x 40.5" x 6.4"	11.6

Galvanized Steel Frame + Aluminum Lid

*Accommodates (32) 12"x12"x1.5" pavers (not included)



INFINITY BASE	WEIGHT	FINISH	SIZE	CUBE
BXI415	415 lbs	SG, AB, AW, SD NEW	44.5" x 44.5" x 1.8"	10
BXI565	565 lbs	SG, AB, AW, SD NEW	44.5" x 44.5" x 1.8"	12.7
BXI715	715 lbs	SG, AB, AW, SD NEW	44.5" x 44.5" x 1.8"	15.3

Galvanized Steel Frame + Aluminum Lid, Galvanized Steel Plates

Mount Kit for ALL STYLES

MKC23 | Concrete
Includes: Adapter plate and expansion bolts.



MKG23 | In-Ground
Includes: In-ground fitting.

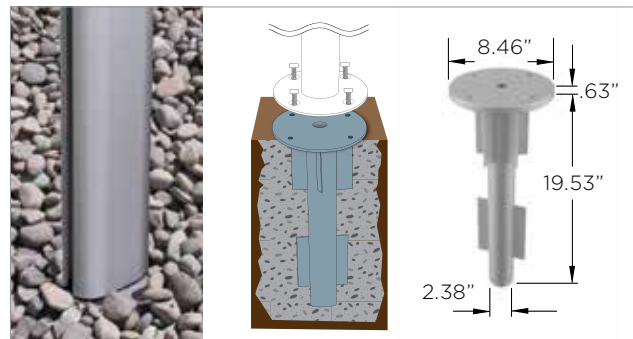

MOUNT KIT	DESCRIPTION	PLATE DIA.	THICKNESS	WEIGHT	CUBE	CASE PK.	CASE WT.	CASE CU.
MKC23	Concrete	8.46"	.63"	7.76 lbs	.16	5	43 lbs	.94
MKG23	In-Ground	8.46"	.63"	16.50 lbs	.91	1	18.26 lbs	.91

Available in Silver Anodized finish only. Can be ordered individually or case pack.
NOTE: External Stem required for Aquarius and Libra styles (sold separately).

BASES WEIGHT MATRIX

Item No.	Size ft m	Canopy Shape	Minimum Base Weight	Mount and Base Options		
				Recommended	Alternate 1	Alternate 2
AQU-23	7.5 2.3	OCT	100 lbs	Athens, Aurora	ZB115	BA150x
AQU-23S	7.5 2.3	SQ	100 lbs	Athens, Aurora	ZB115	BA150x
AQU-27	9 2.7	OCT	100 lbs	Athens, Aurora	ZB115	BA150x
LIB-20S	6.5 2.0	SQ	100 lbs	Athens, Aurora	ZB115	BA150x
LIB-25	8 2.5	OCT	100 lbs	Athens, Aurora	ZB115	BA150x
LIB-25S	8 2.5	SQ	100 lbs	Athens, Aurora	ZB115	BA150x
LIB-27	9 2.7	OCT	120 lbs	Athens, Aurora (+BW30)	ZB115	BA150x
LIB-27S	9 2.7	SQ	120 lbs	Athens, Aurora (+BW30)	ZB115	BA150x
ATL-30	10 3.0	OCT	300 lbs	Infinity Base	(1) ZB115 + (1) ZB225	Titan Base
ATL-30S	10 3.0	SQ	300 lbs	Infinity Base	(1) ZB115 + (1) ZB225	Titan Base
ATL-35S	11.5 3.5	SQ	300 lbs	Infinity Base	(1) ZB115 + (1) ZB225	Titan Base
ATL-40	13 4.0	OCT	400 lbs	Infinity Base	(2) ZB225	Titan Base
AST-40S	13 4.0	SQ	500 lbs	Mount Kit	Infinity Base	(1) ZB115 + (2) ZB225
AST-50*	16.5 5.0	OCT	600 lbs	Mount Kit	Infinity Base	(3) ZB225
AST-50S*	16.5 5.0	SQ	700 lbs	Mount Kit	Infinity Base	(1) ZB115 + (3) ZB225
TAU-30	10 3.0	OCT	300 lbs	(1) ZB115 + (1) ZB225	Infinity Base	Titan Base
TAU-30S	10 3.0	SQ	300 lbs	(1) ZB115 + (1) ZB225	Infinity Base	Titan Base
SOL-27S	9 2.7	SQ	300 lbs	Infinity Base	(1) ZB115 + (1) ZB225	Titan Base
SOL-30	10 3.0	OCT	300 lbs	Infinity Base	(1) ZB115 + (1) ZB225	Titan Base
SOL-30S	10 3.0	SQ	350 lbs	Infinity Base	(2) ZB225	Titan Base
SOL-35	11.5 3.5	OCT	400 lbs	Infinity Base	(2) ZB225	Titan Base
SOLLX-30S	10 3.0	SQ	350 lbs	Infinity Base	(2) ZB225	Titan Base
POL-35S	11.5 3.5	SQ	550 lbs	Mount Kit	Infinity Base	(1) ZB115 + (2) ZB225
POL-340RT	10x13 3.0x4.0	RT	550 lbs	Mount Kit	Infinity Base	(1) ZB115 + (2) ZB225
POL-40	13 4.0	OCT	700 lbs	Mount Kit	Infinity Base	(1) ZB115 + (3) ZB225
POL-40S	13 4.0	SQ	700 lbs	Mount Kit	Infinity Base	(1) ZB115 + (3) ZB225
POLLX-40S	13 4.0	SQ	700 lbs	Mount Kit	Infinity Base	(1) ZB115 + (3) ZB225
ORI-30	10 3.0	OCT	300 lbs	Infinity Base	(1) ZB115 + (1) ZB225	Titan Base
ORI-30S	10 3.0	SQ	350 lbs	Infinity Base	(2) ZB225	Titan Base
ORI-40	13 4.0	OCT	500 lbs	Infinity Base	(1) ZB115 + (2) ZB225	Titan Base
GEM-30S	10 3.0	SQ	400 lbs	Mount Kit	Infinity Base	(2) ZB225

* It is recommended that these items be mounted using our in-ground or concrete mount kits (see page 118).

REPLACEMENT PARTS & OPTIONS

SPECIALTY CANOPY		REPLACEMENT FRAME	REPLACEMENT CANOPY	REPLACEMENT PROTECTIVE COVER	
Item	Available Styles	Item	Item No.	Item No.	
Valance	All Styles	AQU-23	AQU-23	C-AQU-23	CD950-01
		AQU-23S	AQU-23S	C-AQU-23S	CD950-01
Logo Printing	All Styles	AQU-27	AQU-27	C-AQU-27	CD950-01
		LIB-20S	LIB-20S	C-LIB-20S	CD950-01
		LIB-25	LIB-25	C-LIB-25	CD950-01
Designer Canopy	All Styles	LIB-25S	LIB-25S	C-LIB-25S	CD9075
		LIB-27	LIB-27	C-LIB-27	CD950-01
		LIB-27S	LIB-27S	C-LIB-27S	CD9075
		ATL-30	ATL-30	C-ATL-30	CD9076
		ATL-30S	ATL-30S	C-ATL-30S	CD9077
		ATL-35S	ATL-35S	C-ATL-35S	CD9077
		ATL-40	ATL-40	C-ATL-40	CD9077
OPTIONAL FABRIC		AST-40S	AST-40S	C-AST-40S	CD9004
		AST-50	AST-50	C-AST-50	CD9004
		AST-50S	AST-50S	C-AST-50S	CD9009
		TAU-30	TAU-30	C-TAU-30	CD16P
		TAU-30S	TAU-30S	C-TAU-30S	CD16P
		SOL-27S	SOL-27S	C-SOL-27S	CD16P
		SOL-30	SOL-30	C-SOL-30	CD16P
		SOL-30S	SOL-30S	C-SOL-30S	CD16P
		SOL-35	SOL-35	C-SOL-35	CD16P
		SOLLX-30S	SOLLX-30S	C-SOL-30S	CD16P
Glen Raven FIRESIST®	Price Group 1 (+30%)	POL-35S	POL-35S	C-POL-35S	CD36-02
		POL-340RT	POL-340RT	C-POL-340RT	CD36-02
		POL-40	POL-40	C-POL-40	CD36-02
		POL-40S	POL-40S	C-POL-40S	CD36-01
		POLLX-40S	POLLX-40S	C-POL-40S	CD36-01
		ORI-30	ORI-30	C-ORI-30	CD26P-3
		ORI-30S	ORI-30S	C-ORI-30S	CD26P-1
		ORI-40	ORI-40	C-ORI-40	CD26P-1
		GEM-30S	GEM-30S	C-GEM-30S	CD9088-T



FIRESIST® awning fabric combines state-of-the-art flame retardant performance and UV resistance for the commercial awning, canopy and shade markets.

FRAME FINISHES

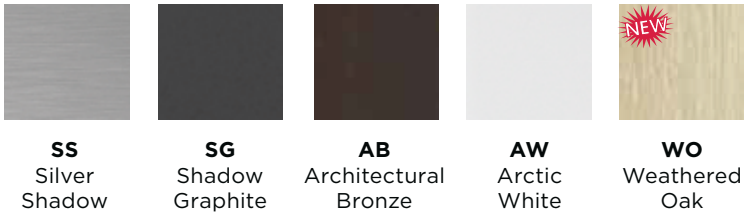

Finishes shown are not to scale. Colors may vary slightly from the actual finish; please refer to the actual frame kit to view true color and detail.
Frame finish collection for umbrella styles and selected bases.
Contact your sales representative for more information and specific lead times.

FABRICS

Price Group 1

Sunbrella®
awning grade
100% Solution-Dyed
Acrylic



4601 Pacific Blue



4602 Sunflower
Yellow



4603 Jockey Red



4604 Natural



4608 Black



4642 Oyster



4644 Charcoal



4653 Mediterranean
Blue Tweed



4677 Tuscan

Price Group 2

Sunbrella®/
Outdura®
furniture grade
100% Solution-
Dyed Acrylic



5401 Pacific Blue



5402 Granite



5403 Jockey Red



5404 Natural



5407 Henna



5408 Black



5413 Spa



5416 Aruba



5417 Tuscan



5422 Antique
Beige



5425 Cocoa



5438 Buttercup



5439 Navy



5446 Forest
Green



5453 Canvas



5461 Taupe



5476 Heather
Beige



5489 Coal



6407 Aquatic



6433 Neptune



6457 Beacon Ash



6662 Harper Steel
Stripe



6667 Kinzie
Smoke Stripe



6668 Kinzie Coal
Stripe

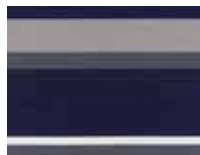

6670 Reliant
Coast Stripe



6671 Pathway
Pumice Stripe

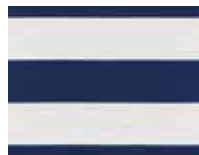

6733 Kinzie Royal
Stripe



7846 Marbled
Meadow



7863 New Block
Smoke Stripe

FABRICS

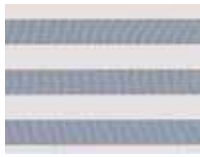

7865 New Block Sea Stripe



8318 Sesame Linen



14087 Gateway Coast Stripe



14106 Seasalt



40428 Cast Ash



40433 Cast Silver



40434 Cast Slate



40456 Cast Lagoon



40524-01 Trusted Fog Stripe



40599-01 Direction Linen Stripe



48080 Spectrum Indigo



48103S Cast Ocean



54011 Ginkgo



54048 Charcoal



56079 Milano Char Stripe



56080 Milano Cobalt Stripe



56095 Astoria Sunset Stripe

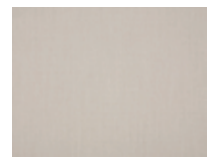

57012 Cloud



58039 Gateway Mist Stripe

Price Group 2
O'bravia®
awning grade
100% Solution-Dyed
Polyester



5801 Cobalt



5803 Red

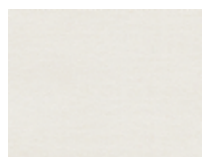

5804 Eggshell



5808 Black



5816 Aqua



5822 Khaki



5825 Mocha



5827 Chocolate*



5839 Navy



5850 Kiwi



5851 Fog

* Limited Fabric Available

NOTE: Striped fabrics must be ordered in pairs, due to cutting requirements. Not available on POL-340RT.
Fabric shown are not to scale. Colors may vary slightly from the actual fabric; please refer to the actual fabric swatch to view true color and detail.

TABLE OF CONTENTS

JCP.101 CENTERPOST ALU 7.5' JCP101-23SQ 9' JCP101-28H	126-127
JCP.201 CENTERPOST ALU 15' JCP201-45	128-129
JCP.301 SIDEPOST ALU 10' JCP301-30SQ 11.5' JCP301-35	130-131
JCP.401 SIDEPOST ALU 10'x14' JCP401-343RT 13' JCP401-40	132-133
JCP.501 QUAD SIDEPOST ALU 10' JCP501	134-135
FINISHES & FABRICS	136
BASES & MOUNT OPTIONS REPLACEMENT PARTS & OPTIONS	137
ACCESSORIES	138
TERMS & CONDITIONS	140-142
WARRANTY / GUARANTEE	144





jardinico®
CARACTÈRE



SHOWN: JCP101-23SQ (TK - Alu Teak) in 10065 Natté Carbon Beige

Visit www.jardinicousa.com for more product information.

JCP.101 CENTERPOST ALU

 7.5 ft Square / 2.3m x 2.3m
 9 ft Hexagon / Ø 2.8m

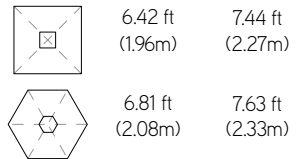
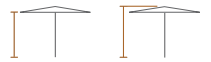

See page **136** for Finish & Fabric Options.

ITEM NO.	SIZE	CANOPY SHAPE	RIBS	FEATURES
JCP101-23SQ	7.5 ft x 7.5 ft (2.3m x 2.3m)	Square	4	<ul style="list-style-type: none"> • Aluminum • Magnodraulic Push-Up Lift System • Self-Locking Canopy Fasteners • Single Wind Vent • Protective Cover
JCP101-28H	9 ft (2.8m)	Hexagon	6	
ITEM NO.	DESCRIPTION	SIZE	FEATURES	
JCB101	Base (with wheels) - 100 lbs.	19.68" x 19.68" x 3.5"	<ul style="list-style-type: none"> • Powder Coated, Hot Galvanized Steel Base with 1.88" Locking Wheels 	

Note: Compatible base must be purchased with frame & canopy. Mount kit option not available.



SHOWN: JCP201-45 (SS - Silver Anodized) in 10022 Natté Grey Chiné

Visit www.jardinicousa.com for more product information.

JCP.201 CENTERPOST ALU

 15 ft Octagon / Ø 4.5m

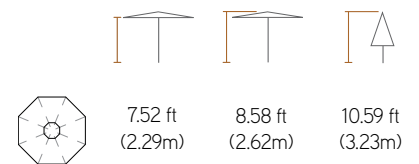

See page **136** for Finish & Fabric Options.

ITEM NO.	SIZE	CANOPY SHAPE	RIBS	FEATURES
JCP201-45	15 ft (4.5m)	Octagon	8	<ul style="list-style-type: none"> Aluminum Telescopic Crank Lift System Self-Locking Canopy Fasteners Single Wind Vent Internal Mast Stem Cover Protective Cover
ITEM NO.	DESCRIPTION	SIZE	FEATURES	
JCB301	Base (with wheels) - 350 lbs.	39.37" x 39.37" x 6.29"	<ul style="list-style-type: none"> Powder Coated, Hot Galvanized Steel Base with 3.75" Locking Wheels 	
JCB-MKC21	Concrete Mount Kit	8.46" plate diameter, .63" plate thickness	Includes: Adapter plate and expansion bolts <i>Adapter plate finish options: 5T, CC</i>	
JCB-MKG16	In-Ground Mount Kit	6.3" plate diameter, .47" plate thickness, 19.53" depth	Includes: In-ground fitting	

Note: Compatible base or mount kit must be purchased with frame & canopy.



SHOWN: JCP301-30SQ (CC - Charcoal) in 5408 Black

Visit www.jardinicousa.com for more product information.

JCP.301 SIDEPOST ALU

☐ 10 ft Square / 3.0m x 3.0m

⬡ 11.5 ft Octagon / Ø 3.5m



Infinite Tilt
Front to Back, Left to Right



	6.89 ft (2.10m)	7.64 ft (2.33m)	12.64 ft (3.85m)	9.73 ft (2.97m)	3.89 ft (1.19m)
	7.06 ft (2.15m)	7.58 ft (2.31m)	12.98 ft (3.96m)	10.04 ft (3.06m)	3.48 ft (1.06m)

See page 136 for Finish & Fabric Options.

ITEM NO.	SIZE	CANOPY SHAPE	RIBS	FEATURES
JCP301-30SQ	10 ft x 10 ft (3.0m x 3.0m)	Square	8	<ul style="list-style-type: none"> Aluminum 360° Rotation Crank Lift System Infinite Tilt (front to back, left to right) Self-Locking Canopy Fasteners Single Wind Vent Internal Mast Stem Cover Protective Cover
JCP301-35	11.5 ft (3.5m)	Octagon	8	
ITEM NO.	DESCRIPTION	SIZE	FEATURES	
JCB301	Base (with wheels) - 350 lbs.	39.37" x 39.37" x 5.25"	<ul style="list-style-type: none"> Powder Coated, Hot Galvanized Steel Base with 3.75" Locking Wheels 	
JCB-MKC21	Concrete Mount Kit	8.46" plate diameter, .63" plate thickness	Includes: Adapter plate and expansion bolts <i>Adapter plate finish options: 5T, CC</i>	
JCB-MKG16	In-Ground Mount Kit	6.3" plate diameter, .47" plate thickness, 19.53" depth	Includes: In-ground fitting	

Note: Compatible base or mount kit must be purchased with frame & canopy.



SHOWN: JCP401-343RT (TK - Alu Teak) in 10020 Natté White

Visit www.jardinicousa.com for more product information.

JCP.401 SIDEPOST ALU

 10 ft x 14 ft Rectangle / 3.0m x 4.3m

 13 ft Octagon / Ø 4.0m

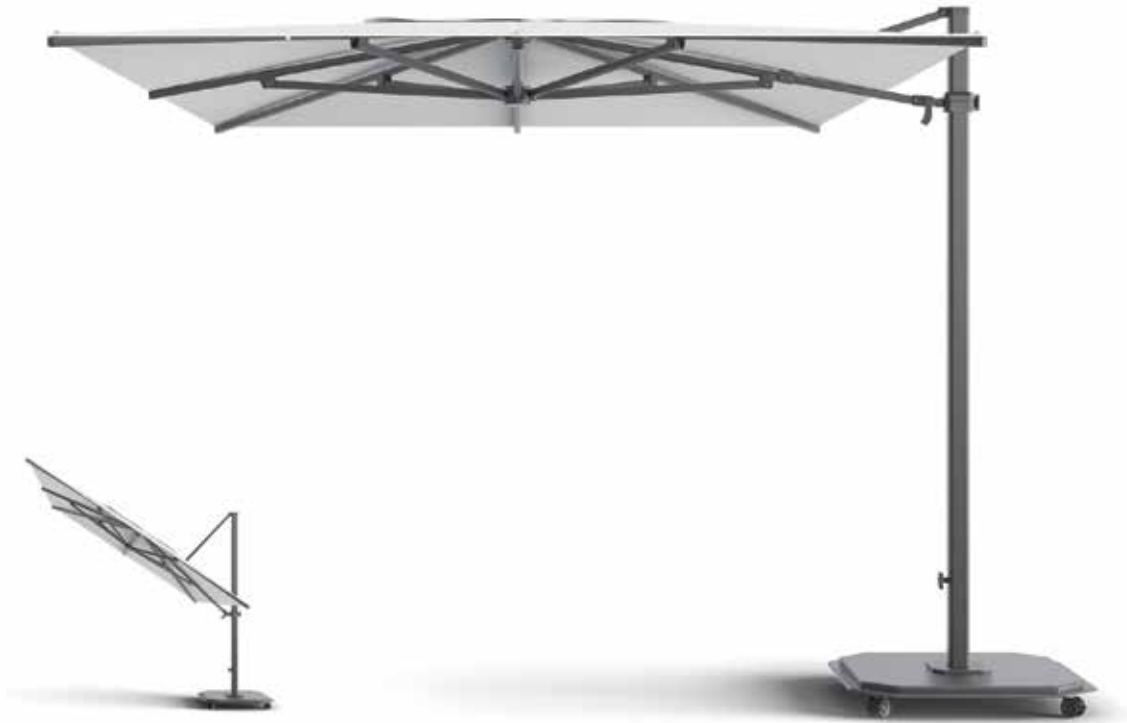

Infinite Tilt
Front to Back

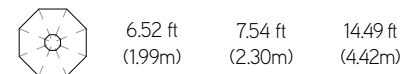
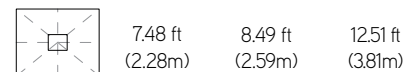
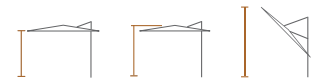

See page 136 for Finish & Fabric Options.

ITEM NO.	SIZE	CANOPY SHAPE	RIBS	FEATURES
JCP401-343RT	10 ft x 14 ft (3.0m x 4.3m)	Rectangle	8	<ul style="list-style-type: none"> Aluminum 360° Rotation Crank Lift System Infinite Tilt (front to back) Self-Locking Canopy Fasteners Single Wind Vent Internal Mast Stem Cover Protective Cover
JCP401-40	13 ft (4.0m)	Octagon	8	

ITEM NO.	DESCRIPTION	SIZE	FEATURES
JCB401	Base (with wheels) - 540 lbs.	39.37" x 39.37" x 6.25"	<ul style="list-style-type: none"> Powder Coated, Hot Galvanized Steel Base with 3.75" Locking Wheels
JCB-MKC25	Concrete Mount Kit	9.84" plate diameter, .63" plate thickness	Includes: Adapter plate and expansion bolts <i>Adapter plate finish options: 5T, CC</i>
JCB-MKG25	In-Ground Mount Kit	9.84" plate diameter, .63" plate thickness, 19.69" depth	Includes: In-ground fitting

Note: Compatible base or mount kit must be purchased with frame & canopy.



SHOWN: JCP501 (TK - Alu Teak) in 5404 Natural

Visit www.jardincousa.com for more product information.

JCP.501 QUAD SIDEPOST ALU

 10 ft Square / 3.0m x 3.0m

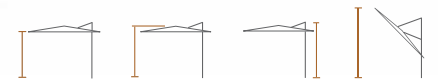

7.50 ft
(2.29m)

8.25 ft
(2.51m)

9.75 ft
(2.97m)

16.33 ft
(4.98m)



Infinite Tilt Front to Back -
Canopies can open and tilt individually

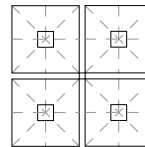

JCP501

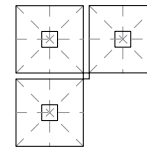

JCP501-P3

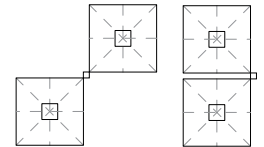

JCP501-P2
Diagonal or Adjacent

See page 136 for Finish & Fabric Options.

ITEM NO.	DESCRIPTION	CANOPY SHAPE	RIBS	FEATURES
JCP501	Frame & (4) Canopies	Square 10 ft. (3.0m x 3.0m)	8 per canopy	<ul style="list-style-type: none"> Aluminum Up to 430.5 sq. ft. of Coverage Crank Lift System Infinite Tilt (front to back) Each Canopy Opens and Tilts Individually Self-Locking Canopy Fasteners Single Wind Vent Internal Mast Stem Cover Protective Cover
JCP501-P3	Frame & (3) Canopies			
JCP501-P2	Frame & (2) Canopies			

ITEM NO.	DESCRIPTION	SIZE	FEATURES
JCB-MKC501	Concrete Mount Kit	9.84" plate diameter, .63" plate thickness	Includes: Adapter plate and expansion bolts <i>Adapter plate finish options: 5T, CC</i>
JCB-MKG25	In-Ground Mount Kit	9.84" plate diameter, .63" plate thickness, 19.69" depth	Includes: In-ground fitting

Note: Mount kit must be purchased with frame & canopy.
See page 137 for optional (one-piece) Gutter.

FINISHES & FABRICS

Finishes



SS
Silver Anodized



CC
Charcoal



MW
Matte White
(Special Order)



TK
Alu Teak
Not available on JCP201
(Special Order, 5% Upcharge)

Fabrics



10020
Natté
White

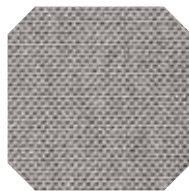

10022
Natté
Grey Chiné

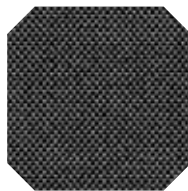

10059
Natté
Dark Taupe

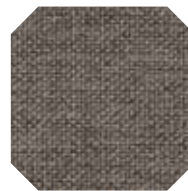

10065
Natté
Carbon Beige

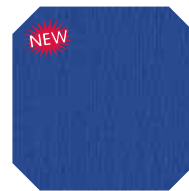

5401
Pacific
Blue



5404
Natural



5408
Black



5413
Spa



5417
Tuscan



5439
Navy

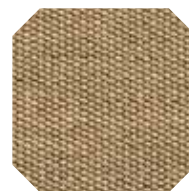

5476
Heather
Beige



5489
Coal

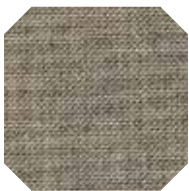

40428
Cast Ash



40433
Cast Silver

*For additional fabric options, contact your Sales Representative.
(Special Order, 20% Upcharge)*

NOTE: Fabric and finishes shown are not to scale. Colors may vary slightly from the actual fabric and finish; please refer to the actual fabric swatch and frame sample to view true color and detail.

BASE & MOUNT OPTIONS

Compatible Base with Locking Wheels

Base finish matches frame finish except for TK (Alu Teak) which uses the CC (Charcoal) finish.



Locking all weather wheels rotate 360°.

ITEM NO.	DESCRIPTION	SIZE	WEIGHT	FEATURES
JCB101	Base (with wheels)	19.68" x 19.68" x 3.5"	100 lbs.	<ul style="list-style-type: none"> • Powder Coated • Hot Galvanized Steel Base • Locking Wheels
JCB301		39.37" x 39.37" x 5.25"	365 lbs.	
JCB401		39.37" x 39.37" x 6.25"	540 lbs.	

Compatible base must be purchased with frame & canopy. Compatible base not available for JCP.501.

Compatible Mount Kits

Mount Kit options for concrete and in-ground mounting.

SERIES	MOUNT KIT	ITEM NO.
JCP.201 JCP.301	Concrete*	JCB-MKC21
JCP.401 JCP.501	In-Ground	JCB-MKG16
JCP.401 JCP.501	Concrete*	JCB-MKC25
JCP.401 JCP.501	In-Ground	JCB-MKC501
JCP.401 JCP.501	In-Ground	JCB-MKG25

Compatible Mount Kit must be purchased with frame & canopy. Mount kit not available for JCP.101.

*Available in 5T - Platinum | CC - Charcoal



MUST CHOOSE FINISH WHEN ORDERING.

REPLACEMENT PARTS & OPTIONS

Replacement Canopy

SERIES	FRAME	ITEM NO.
JCP.101	JCP101-23SQ	CJ1-23SQ
	JCP101-28H	CJ1-28H
JCP.201	JCP201-45	CJ2-45
JCP.301	JCP301-30SQ	CJ3-30SQ
	JCP301-35	CJ3-35
JCP.401	JCP401-343RT	CJ4-343RT
	JCP401-40	CJ4-40
JCP.501	JCP501	CJ5-30SQ

Replacement Protective Covers

SERIES	ITEM NO.
JCP.101 (All sizes)	JA-CP902
JCP.301 (All sizes)	JA-CD35D
JCP.401 (All sizes)	JA-CD36-02
JCP.501	JA-CD39

Optional (one-piece) Gutter

Custom made and available for JCP.501 styles.



To span big surfaces and canalize rain-water, you can connect several umbrellas with a gutter.

ITEM NO.: **CJ501G**

ACCESSORIES

MOROCCAN LANTERN



ITEM NO.	SIZE	HEIGHT	WIDTH	WEIGHT	CUBE
JCA-MOR-SM	Small	15.0"	11.0"	10 lbs.	2.52
JCA-MOR-MD	Medium	19.7"	11.0"	12 lbs.	3.02
JCA-MOR-LG	Large	26.8"	11.0"	14 lbs.	3.52

ANTIBES WINE TUB



ITEM NO.	HEIGHT	WIDTH	WEIGHT	CUBE
JCA-ANT-WTB	9.5"	18.13"	20 lbs.	4.14

ANTIBES WINE COOLER



ITEM NO.	HEIGHT	WIDTH	WEIGHT	CUBE
JCA-ANT-WCO	11.5"	10.63"	9 lbs.	1.64



Lights sold separately



Shade as a style statement.

jardinico[®]
CARACTÈRE



BRANDS

Terms & Conditions (subject to change without notice)

PAGES 140-142 applies to Treasure Garden, Shademaker and Jardinico.

As a condition of doing business with Treasure Garden, Inc. and its affiliates (hereinafter, "TG") all persons involved in the commercial purchase, sale, or resale of TG products (each, a "Dealer") shall be bound by the following terms and conditions (the "Agreement").

Distribution:

To qualify as an authorized TG retail Dealer a business must:

- Have a permanent store-front retail business location with reasonable space to display TG products and accessories.
- Maintain an inventory of TG merchandise throughout their outdoor product selling season.
- Reasonably accommodate purchases of anyone showing interest in TG products.
- Be moderately capable of "after the sale" service and support to the end-user and reasonably accommodating of consumer requests for such service and support.
- Retail Dealers should be qualified or trained by their TG sales representative.
- Ecommerce and contract dealers have other requirements.

TG reserves the right to respond to geographic and individual market and competitive situations by applying different policies to its various Dealers. TG also reserves the right to rescind or modify, in its sole and absolute discretion, any existing or future sales program or policy, or the credit terms (if any) extended to a Dealer. In addition, TG may terminate any authorized Dealer, for any reason or no reason, in its sole and absolute discretion and without notice.

Credit Terms:

A completed and signed TG commercial credit application agreement begins the process of establishing a credit line or billing account with TG. Until a credit application is approved, all orders may require payment in advance; meaning payment must be paid prior to our manufacturing of the order. Minimum annual orders of \$5,000 are required during TG's fiscal year (i.e., Oct. 1 - Sept. 30) for any new or re-established account. TG generally offers payment terms of Net 30 days (on approved credit) to an authorized retail dealer. Terms for contract dealers are proforma / cash in advance. Other credit terms may be available and will be indicated on the Sales order acknowledgement and Invoice. Payment terms for Freight Charges and/or duties are Net 7 days. All orders are subject to credit approval and acceptance by our home office in Baldwin Park, California and TG may terminate the extension of credit, for any reason or no reason, in its sole and absolute discretion. Any disputes between TG and a Dealer may be brought in the Courts located in California regardless of where the Dealer is located. Time is of the essence concerning all payments, and payments must be sent to be received by the due date. No deductions or debit memos are accepted. A service charge of one and one-half percent (1.5%) per month or such maximum lesser rate as may be permitted by law may be assessed to all past due invoices. Invoices are considered past due if the payment is not received by the due date.

Credit files are routinely reviewed, and a current financial statement or information may be requested by TG and must be provided within 10 business days. TG may also request assurances of a Dealer's ability to pay and may, upon the making of such request, stop production and suspend shipments.

Prices:

Prices listed in the price list are suggested retail prices. A Dealer's cost is based on the designated Dealer classification. Ask your Sales Representative for details regarding TG's 2025 programs and pricing structure.

Taxes and Surcharges:

The manufacturer's suggested retail price (MSRP) does NOT include any state tax local tax or surcharges. CA sales tax may apply to shipments made within the state of CA, picked up at our CA facility or drop shipped within the state of CA unless we have a CA resale or tax-exempt certificate on file. Treasure Garden has a presence in 39 states. As of JUNE 2022, these states are AL, AR, AZ, CA, CO, CT, DC, FL, GA, IA, ID, IL, IN, KS, KY, LA, MA, MD, ME, MI, MN, MO, NC, NE, NJ, NM, NV, NY, OH, OK, PA, RI, SC, TN, TX, UT, VA, WA & WI. As mandated by state and local taxing authorities, we are required to collect sales and / or use taxes on your purchases shipped to these states unless we have a valid resale / tax exemption certificate(s) for the state(s) that your company's purchases are shipped to. Please note that CA, CT, DC, MA & MD will NOT accept another states resale certification or resale number for tax exempt purposes.

Order Acceptance:

We accept orders from an authorized retail Dealer or contract accounts only. Ask your sales representative for details on becoming an authorized retail Dealer or contract account. If you place an order with Treasure Garden and you or your designee accepts delivery of any goods in relation to the order (whether or not you believe the delivery conforms with the order) you will be bound by the terms and conditions of our 2025 catalog.

If you do not accept all of the Catalog Terms you must notify us in writing within 10 business days of receiving your acknowledgement or the goods, whichever occurs sooner, to cancel or return the order at your expense. If you fail to do so, you will be bound by the Catalog Terms. In the event of a conflict between the terms on any purchase order, invoice, acknowledgement, or other document and the Catalog Terms, the Catalog Terms will prevail.

Opening orders under \$5,000 (or dealers without open credit terms):

Orders must be paid in advance via ACH, wire, credit card, business check, or cashiers check before the order is manufactured (we do not process C.O.D. orders or hold credit card information on file). Once your order is sent in, please allow at least 3-5 days for us to process and price your order. We will email an order quote with your prices, estimated shipping charges and prepayment instructions. Once your payment is cleared from the bank, a new acknowledgement will be issued with your estimated ship date. Clearing of checks may take anywhere from 3-5 business days for any checks issued from domestic banking institutions.

International checks are not accepted. It is best to pay orders via Wire Transfer on all international orders to avoid delays in processing.

Opening orders over \$5,000:

Please send in a TG credit application with your order, all Dealers will be bound by this Agreement regardless of whether they sign the TG Credit Application Agreement. Allow a few days for account set up and credit application processing. Once credit terms are approved, please refer to your order acknowledgment for the ship dates. If you do not wish to establish open terms, please review the preceding section.

Order Policy:

To ensure that your order is processed without delay we require:

- A written purchase order (no phone orders) from an authorized Dealer including the business name, account number, phone number and purchase order number.
- Ship date and specific shipping instructions. If you request freight collect or 3rd party billing, please provide the account number.
- Our item/style number, fabric number, type and color.
- Quantity of each style.
- Customer's name on all Special Orders.
- Order type:

SP = Special Promotions	EEB = Early Early Buy
TGEX = TG Express Order	EB = Early Buy
CQS = Cantilever Quick-Ship	

NOTE: Dealers who place a single purchase order without specifying a specific program, the order will automatically be shipped out at the longer lead time based on the items ordered. Dealers who want separate shipments with different lead times (i.e. – TGEX and Custom), please write separate purchase orders per program and make sure correct items are offered in those programs. Dealers who place a single purchase order specifying multiple or incorrect programs based on items ordered, the order will automatically be split-shipped separately according to their respective programs.

A 50% deposit may be required for orders that contain custom, exclusive items or large quantities. The deposit must be made before the order is scheduled into our system.

Please note that any discrepancies in your purchase order can cause significant delays. You must review the acknowledgment for accuracy and advise TG immediately of any discrepancies or changes. Lead time starts once order is finalized.

Changes/Cancellations:

No cancellations, changes, additions or holds will be accepted for an order for which materials have been ordered or produced. Cancellations and/or changes of product or shipping dates on EARLY BUY orders (as defined below) must be received at our office in writing within 15 days of the acknowledgement date. Cancellations and/or changes of product or shipping dates on custom orders must be received in writing within 3 business days of the acknowledgement date. Order revisions will no longer be accepted for Quick-Ship programs if the order has already been processed in the system or after 24 hours, whichever occurs first. No cancellations or revisions will be accepted after 72 hours for non-stock fabric orders. NO EXCEPTIONS. Orders that do not follow these guidelines will be charged a 25% re-stocking or handling fee. We cannot guarantee that purchase orders added to an existing order will be shipped together. If items are added to an order or an item on an order is changed, the entire order may be rescheduled as of the date of the change. This may result in a later ship date than the original order. In the event an order is refused and returned to us, a 25% restocking/handling fee may be assessed in addition to the inbound and outbound freight charges. The 25% restock fee also applies to pro forma orders that are canceled due to nonpayment.

Container Orders:

Due to the special pricing on container orders, all containers must be prepaid via wire transfer or paid by letter of credit. If you have not placed a prior container order or if there were previous payment delays or if there are non-stock/custom items on the order, we may require a 50% deposit before we start manufacturing the order. The remaining balance will be due two weeks before the order is shipped. The purchase of a container may also involve bank charges and other charges unrelated to the price of the product including but not limited to duties, storage, shipping, and transportation charges, third party inspection charges whether inspected at point of origin, point of entry or point of delivery. Once your purchase order is sent in, we start reviewing and scheduling your order into our production schedule. It is important that you inform the Baldwin Park office of any order changes within 10 business days from when your order is sent in. After reviewing your purchase

order, we will mail or fax an order acknowledgement with your payment instructions. We must be informed of any discrepancies or revisions to CONTAINER ORDERS in writing within 10 business days of sales order acknowledgment date. No cancellations are allowed. When placing orders, please be mindful of Chinese New Year. Generally, our manufacturing schedule is tight around that time.

Backorder/Partial Shipments:

Due to the considerable number of items, we offer, we may not initially be able to ship or deliver your entire order. In such event the balance and/or entire order thereof will be backordered and shipped and delivered at a subsequent time or times. Standard shipping charges will apply to partial or backorder shipments.

Lead Times:

TG CUSTOM: Our goal is to ship custom in stock fabric orders within 3 weeks of the acknowledgement of the order, 5 weeks for non-stock fabrics for Treasure Garden and Shademaker; 8-10 weeks for non-stock fabrics for Jardinico.

EARLY BUY: We will make every effort to ship orders received during the EARLY BUY period within 30 business days of the estimated ship date. All scheduled shipments will be at the factory's convenience.

TGEX: Our goal is to ship TG EXPRESS orders within 2 business days of the acknowledgement of the order.

CQS: Our goal is to ship CANTILEVER QUICK-SHIP orders within 5 business days of the acknowledgement of the order.

Notwithstanding anything to the contrary herein, TG does not guarantee that any shipments of any type of product or order will be delivered at or before a date certain. All large quantities may result in partial shipments. This is a goal – not a guarantee – and may be slightly affected by availability of fabrics & consumer demands.

ALL SHIPMENTS - TG shall, in the event of no routing instructions from the buyer; select a carrier, which it feels, in its sole discretion, can adequately handle each shipment.

Order Scheduling:

Deliveries are subject to fire, storm, flood, war, rebellion, riot, strike or labor trouble, interruptions to transportation, perils of navigation, damage to factory, equipment of facilities, governmental mandates, including the exercise of acts of God, failure of our sources of supply in whole or in part, and other cause beyond our control. We shall not be liable for any damages or failure to deliver or delay in delivery due to any such causes. If possible, we will attempt to ship merchandise the week of the requested ship dates.

However, in order to maintain an orderly schedule, we reserve the right to schedule the merchandise shipment to the nearest available production schedule and to ship accordingly.

Our regular business days are Monday through Friday.

Early Buy Orders:

The deadline for the 2025 Season Early Buy Program is December 31, 2024. These dates are subject to change depending on our production schedule. Due to special payment terms of the Early Buy order, we are unable to restrict or limit the shipping dates; you must be prepared to accept shipment of the Early Buy order at TG's sole convenience. There is a minimum of \$5,000 for Early Buy orders. A 50% deposit may be requested for customers placing their 1st Early Buy order if there were issues with previous orders, the order exceeds the approved credit line or there is custom product that is being ordered. The deposit must be made before the order is scheduled into our system. Ask your Sales Representative for details on our EARLY BUY program.

Freight Charges:

The shipping charges on your invoice may differ from those on your acknowledgement. This is largely due to instability in today's fuel economy. Please understand that these charges are assessed by the carrier, not TG. These charges can sometimes include fuel surcharges, lift gate, extra delivery charges, as well as standard pallet fees and box pallet fees which may not have been indicated on the preliminary freight quotes. The pallet fees may increase depending on the cost of these items.

If the freight charges are prepaid & added to your invoice, the shipping charges may include any applicable pallet charges. To ensure the most economic freight for our customers, we are constantly reviewing freight rates. If we ship your orders freight collect or 3rd party billing, we will bill your company for any applicable pallet charges.

Freight Claims:

All merchandise is delivered to the carrier in factory new condition. Our FOB shipping points are AZ, Baldwin Park, CA or Ningbo, China.

The FOB location depends on your order type and product availability. The carrier accepts responsibility for the safe delivery upon acceptance of the shipment.

TG should be notified immediately regarding any claims. Claims for loss or damage sustained in transit must be filed by the Dealer, as follows:

Visible Damage:

It is the Dealer's responsibility to check the merchandise and file a claim with the carrier if the shipment was made using the dealer's carrier and account. Request a claim form from the delivering carrier and file your claim immediately. If the shipment was made using TG's carrier and account, it is the Dealer's responsibility to check the merchandise and notify TG immediately of the situation so that a claim can be filed. In either situation, make a notation on the Bill of Lading/Proof of Delivery as to the nature and extent of the

damage and obtain a signature of the carrier's agent. (Failure to adequately describe this information may result in the carrier refusing to honor the claim and TG will not, under any circumstances, be liable for damage sustained in transit).

Concealed Damage:

If damage is discovered when unpacking the merchandise, immediately mark the damaged area and submit a written request for the carrier to inspect. Attach a copy of the concealed damage information. Do not remove the merchandise from the original carton until the carrier inspection is complete. If the merchandise was shipped using TG's carrier and account, it is the Dealer's responsibility to notify TG immediately of the situation so that a claim can be filed. Concealed damage needs to be reported and claim filed within 5 days for all carriers.

Shortage:

It is the Dealer's responsibility to inspect all merchandise and to file claims with the carrier in the event of product shortage. Make a notation on the Bill of Lading/Proof of Delivery as to the number of cartons short. TG must also be notified immediately of any shortages. File the claim with the delivery carrier immediately. No claim for shortages, damaged items or errors will be honored unless it is made in writing on the Bill of Lading immediately upon receipt of the shipment. Notwithstanding anything to the contrary in this Agreement, failure to make a claim on the Bill of Lading will constitute a waiver of any rights to a refund or credit.

Return Goods:

No returns will be accepted without a written Return Authorization (RA#) from the factory. A request for return must be done within 30 days of delivery and all RA's are valid for 60 days. It is the Dealer's responsibility to follow routing instructions. Please email your Customer Service Representative for an RA#. Your request must include the following information:

- Company name, contact name, number & store hours,
- The TG invoice and/or acknowledgement,
- The item no., number of units to be returned and carton total,
- The reason for the return, and
- Which carrier will be returning the goods and the date of the shipment.

Any item that is returned for credit that is not under TG's warranty policy is subject to a 25% restocking fee (and must be properly packaged) plus inbound and outbound freight charges, if applicable. Any item that is returned for repair or replacement that is not under TG's warranty policy is subject to the applicable repair charges listed in the "Other Fees" section, below. FOR FULL CREDIT CONSIDERATION, RETURNED MERCHANDISE MUST BE BOXED & IN NEW CONDITION. TG will only organize the return of product for warranty determination from the original point of shipment within the US and Canada. Per the Treasure Garden Limited Warranty, Treasure Garden restricts warranty service for TG products to the country where Treasure Garden or its authorized TG retail Dealers originally sold the product.

Errors:

There may be errors in the prices, descriptions or images of certain merchandise in our price list or sales material. We reserve the right to restrict orders of those items.

Other Fees:

These fees apply to both contract accounts and retail Dealers.

- Non-warranty repairs are subject to a labor charge of \$50 per hour plus applicable parts, inbound and outbound freight charges. Please allow at least 5 business days for processing.
- A \$15 handling fee will be added to any purchase under \$50. To avoid this fee, please accumulate your product needs and place orders together. DOES NOT APPLY TO PARTS, FABRIC BY THE YARD OR DISPLAY STANDS.
- A \$15 drop shipment fee will be added to drop shipment orders. We can drop ship orders to US addresses only. The appropriate sales and use tax will be added to the orders unless we have a resale certification for the state that the items are being shipped to. Depending on the item, additional delivery charges may apply. TG reserves the right to rescind or modify, at its sole discretion, drop shipments or the drop shipment of specific items.
- A \$25 service charge will be assessed on any returned check.
- Residential delivery fees, lift-gate fees, limited access and "call before delivery" fees vary depending on the carrier.
- A Materials Handling Fee may be assessed for palletized orders shipping LTL freight collect or when special labels are required to print for each order.

Shipping:

Most TG products can be shipped using parcel companies (UPS, FedEx or other). Some of our larger or heavier products however, must be shipped with a trucking company. Such products are identified with the "Truck Only". TG can only ship to addresses in the US and Canada. If shipping to Canada, you must have your own broker to clear items through customs and this information must be provided with the purchase order.

Treasure Garden Storage Policy:

We reserve the right to assess storage fees if you are not able to receive the product when Treasure Garden is ready to ship, your carrier does not pick up within 3 days of notification that the shipment is ready or after a 3-day grace period*. The grace period starts the day after the original Estimated Ship Date on your Order Acknowledgement (or the date the product is ready to ship). When the grace period expires, the following storage policy and pricing will be applied:

- Un-palletized orders are \$50 per day*
- Palletized orders are \$50 per day*; plus an additional \$20 per pallet

*All time frames referenced in policy are business days

† Customer is responsible for all shipping charges if they are unable to receive shipment when carrier is ready to deliver. This includes but is not limited to, storage and re-delivery fees. †† Storage is not available for Cash In Advance / prepay customers.

Payments:

Payment will be accepted in US Dollars only. If a deposit or pre-payment is paid by a standard business check drawn on a domestic banking institution, please allow 2-5 business days from TG's deposit date for your funds to clear. If paid by a standard business check drawn on an international banking institution, please allow 4-6 weeks from TG's deposit date for your funds to clear. If your deposit is prepaid via wire transfer, please allow 1 business day for your funds to clear. Invoice payments should be sent to be received on or before the due date at our corporate office in Baldwin Park, CA at the address in the "Notices" section, below. Payments made in a different manner may be delayed.

Pricing:

"MSRP" means the Manufacturer's Suggested Retail Price as set forth in this Catalog. "MAP" means the Minimum Advertised Price as set forth in this paragraph. Dealers must adhere to MAP requirements when advertising via any traditional media, in all online advertising, online comparison price shopping, and landing pages. Dealers cannot advertise TG products below a published Net MAP price list effective the start of each fiscal year. TG reserves the right to adjust MAP pricing based on MSRP and/or MSRP pricing, changes due to tariff implementation and/or other unforeseen market conditions, as needed during the fiscal year. This net pricing is inclusive of, but not limited to, discounts such as coupons, promo codes, email "sign up" discounts and sales tax. In addition, no advertisements may state or otherwise suggest that the TG MSRP is higher than the actual MSRP as set forth in this catalog. It is also incumbent on all dealers to update their pricing October 1, 2024 for 2025 season to reflect any changes to MSRP and MAP that might occur. MAP Policy may vary for international dealers, please see your local sales representatives for details.

Minimum Advertised Price Requirements:

As in any Minimum Advertised Price ("MAP") program, the intent is to uphold the integrity of the Treasure Garden line of products and protect the investments made by Treasure Garden and its Dealers and retail partners. Violating MAP requirements only serves to devalue the brand in the eyes of the consumer. These MAP requirements apply to any Dealers advertising TG products via traditional media including, but not limited to, newspapers, mailers, inserts, circulars, magazines, catalogs, television and radio. In addition, the MAP requirements apply to any Dealers selling or advertising TG products online and/or having a checkout/cart system.

MAP Policy Violation Enforcement:

TG reserves the right to determine, in its sole and unfettered discretion, whether a violation of the MAP requirements has occurred. If TG determines that a Dealer has violated the MAP requirements, TG may, in its sole and unfettered discretion, terminate its relationship with the Dealer without notice or an opportunity to cure. The Dealer agrees that money damages or other legal remedies would not, standing alone, be a sufficient or adequate remedy for any breach or violation of the MAP requirements. As such, in addition to all other remedies available to TG, TG shall be entitled to an injunction restraining such breach or violation and to other equitable relief, including specific performance, without a bond or other security being required.

Product Advertising:

All TG products advertised may include the Treasure Garden name in the product description. Product advertising may include proprietary names (e.g., O'bravia®, Solefin®, etc.) and the Treasure Garden logo in product descriptions. Product names cannot be changed without prior approval (e.g. EVO, Polaris, etc.). Dealers may use their own images of TG products that they have taken themselves OR use images offered in TeamTG. Treasure Garden logos and logos of proprietary products will be provided on TeamTG. Lifestyle images provided by Treasure Garden should not be altered without prior approval. The Dealer's permission to use the Treasure Garden brand, trade names, logos, images, and any intellectual property is subject to the Dealer's strict compliance with this Agreement including, but not limited to, the MAP requirements.

Bulk Sale Restrictions:

If a Dealer decides to resell product to a third party said Dealer is responsible for any warranty or service issues, as well as is still bound to this agreement. The third party is not under agreement with TG, it is the Dealer that is doing business with TG.

Duty to Notify TG of Complaints:

Dealers shall make a careful and thorough inspection of all goods received. Subject to and without limitation of the requirements of the "Freight Claims" section above, Dealers must notify TG in writing of any complaints or issues, whether existing or reasonably foreseeable, relating to TG's performance including, but not limited to, discrepancies in quantity or description of items delivered, defects or potential defects in items delivered, or any other issue whatsoever relating to TG's performance (except issues relating to billing disputes, which are dealt with in the next section.) Notice shall be provided to TG within 30 days of:

(i) the Dealer's receipt of any defective or non-conforming goods, or (ii) the time any other issue complained of came, or should, with reasonable care, have come to Dealer's attention – whichever is earlier. Unless timely notification is received by TG in accordance with the terms hereof, which notice shall identify with particularity all complaints or issues asserted by the Dealer, the Dealer irrevocably waives any and all complaints relating to any defective or non-conforming product or any other issue whatsoever relating to TG's performance and the Dealer shall have no recourse against TG. The Dealer shall be solely responsible for retaining proof that the written notice required by this section was received by TG.

Payment Obligations:

Dealers agree to examine immediately upon receipt each of TG's statements of account, invoices, or other billing statements (collectively, "Bills"), and to notify TG in writing of any

disputed Bills within 10 days of receipt. Such disputes may include, but are not limited to, disputes relating to charges for items that were billed but not received; charges for product that was received but not ordered; or charges for items that were returned, refused, credited, or have a freight claim pending. Dealers will not withhold payment when disputes arise. Only the disputed portion of a timely disputed past-due balance may be withheld. Unless timely notification is provided to TG in accordance with the terms hereof, which notice shall identify with particularity any and all objections to any of TG's Bills, the Dealer irrevocably waives any and all objections to TG's Bills. In addition, the Dealer agrees that its obligation to pay TG is separate and independent from any obligations TG may have to the Dealer. In the event the Dealer fails to pay TG in accordance with the terms hereof, the Dealer irrevocably waives the right to assert any and all claims, offsets, or any other defenses whatsoever to TG's right to payment. The Dealer further agrees that any payments to TG may be applied to any invoices or other indebtedness owed to TG, in TG's sole and absolute discretion. The Dealer shall be solely responsible for retaining proof that the written notice required by this section was received by TG.

Statements are sent out on the 1st business day of each month and mid – month.

Adequate Assurance & Right to Suspend Delivery:

Without limitation to any of TG's rights hereunder, if the Dealer fails to fulfill the terms of payment of any invoice, or fails to perform any other obligation whatsoever to TG or if there is change in ownership or if the financial condition of the Dealer shall become impaired or unsatisfactory to TG in TG's sole discretion, or if necessitated by any acts of governmental authority, TG reserves the right to change the terms of payment, discontinue further shipments, and/or cancel all orders and deliveries in progress to Dealer, without notice, until all past due payments are made in full or such acts of governmental authority shall have been complied with or Dealer has provided security satisfactory to TG, in TG's sole discretion, which may include, by way of example only, cash in advance or proforma terms.

Attorneys' Fees:

The Dealer agrees that it shall be liable for all of TG's attorneys' fees (including local counsel fees), experts' fees, accountants' fees, court fees, collection costs, collection agency fees (if applicable), and any other expenses, whether or not incurred in connection with litigation or arbitration, arising from the breach of any term of this agreement by the Dealer, and/or in connection with the enforcement of any judgment or award rendered in favor of TG.

Governing Law:

You agree that all matters relating to your purchase and use of TG products, including all disputes, will be governed by the laws of the United States and by the laws of the State of California without regard to its conflicts of law provisions. You agree to the personal jurisdiction by and venue in the state and federal courts in Los Angeles County, California, and waive any objection to such jurisdiction or venue.

No Waiver:

None of TG's rights hereunder will be deemed to be waived or modified in any way based upon the manner in which this Agreement is performed or TG's failure to enforce its rights hereunder or insist on strict and timely performance of the Dealer's obligations. Without limitation to the foregoing, acceptance of payment outside of the stated credit terms shall not operate as a waiver of the stated credit terms.

Limitation on Liability:

In no event will TG be liable to the Dealer for any lost profits, lost savings, or any consequential, incidental or special damages arising out of or in connection with the parties' relationship, even if TG has been put on notice of the possibility of such damages. Without limitation to the foregoing, under no circumstances will TG be liable to the Dealer for punitive damages.

Disclaimer:

Please note that TG, reserves the right to alter or modify product styles and to discontinue frames and fabrics without notice. For more information about TG products, please contact us at: (626) 814-0168 or email: info@treasuregarden.com

Mount Kit Disclaimer: The mount kit should only be professionally installed by a licensed contractor. Treasure Garden® assumes no liability and expressly disclaims any responsibility for injuries or damages arising from or related to the failure of buyer to have the mount kit installed by a licensed professional contractor. Treasure Garden makes no warranty except as expressly stated herein, and no warranty except Title to Materials furnished shall be implied with respect to this order.

Disclaimer of Warranties: Except as herein expressly set forth, this product is sold "as is" and "with all faults", and without any implied warranty of merchantability – which warranty is hereby expressly excluded. This product is sold without any implied warranty of fitness for a particular purpose – which warranty is hereby expressly excluded. Moreover, there are no warranties which extend beyond the description on the face hereof.

Notices:

All written notices required hereunder shall be ineffective unless sent to the following addresses by Federal Express and email:

info@treasuregarden.com – and – **Treasure Garden, Inc.**
13401 Brooks Drive
Baldwin Park, CA 91706

Headings:

Section headings are inserted for ease of reference only and shall have no effect on the interpretation of this agreement.

Warranty/Guarantee

Treasure Garden items are designed for residential use and are not warranted for commercial applications (unless specified for Commercial use).

LIMITED WARRANTY (Frames and Accessories)



Three (3) years
FLEX styles



Two (2) years
Starlux AKZ Plus Cantilever styles
AKZ Plus Cantilever styles
AG25T Cantilever styles
Shanghai Collar Tilt style
TWIST *tilt* style
Starlux Collar Tilt style
Collar Tilt styles
Auto Tilt styles
Aspen Base



One (1) year
Starlux AKZ Plus Rechargeable Battery Pack
AG19A Cantilever style
Quad Pulley Lift style
Glide Tilt styles
Push Button Tilt styles
Umbrella Bases & Accessories
Umbrella Lights
Outdoor Rugs
Protective Furniture Covers

Limited Warranty Includes:

Powder coated finish, frame, ribs, finial, tilt, cord, crank handle, housing, canopy and rib pocket seams. If a defect in the original material or workmanship appears during the warranty period on any Treasure Garden product; Treasure Garden, at its option, will repair or replace the product without charge.

Authorized Retailer:

Requests for returns must be FAXED in to (888) 821-8868
Attn.: Customer Service or contact a Customer Service Rep.

Limited Warranty Fabric (Furniture Grade):

The following fabric lines have a limited warranty against fading for:
5 years - Sunbrella®/Outdura®/Bliss
4 years - O'bravia®

The Limited Warranty only applies to TG product purchased directly from Treasure Garden, Inc. and its affiliates, or an authorized TG retail Dealer, as defined in our Terms and Conditions; the Limited Warranty is not transferable. Should the Purchaser or Owner sell the TG product to another party, the warranty will not transfer to the new owner.

What Is NOT Covered:

Failure caused by unreasonable or abusive use, or failure caused by neglect of reasonable and necessary care, and any modification to product are not covered by this warranty. We will only warranty products which are properly secured to an adequate base or mounting system and adhere to our required base weight minimums.

Additionally, acts of nature (including but not limited to wind, hurricanes, tornadoes, and storms) are not covered by this warranty. This warranty covers return freight of any warranted product only for the first year. This warranty gives you specific legal rights and you may have other rights which vary from state to state.

Closeout and promotional items sold by the dealer "as is" are not covered by this warranty.

Wind Damage:

Treasure Garden highly recommends that no umbrella, regardless of size or weight, ever be left unattended in the open position. In windy conditions, it is further recommended that umbrellas be closed, removed from their base, and stored or laid horizontally. This will reduce the risk of personal injury, damage to your umbrella, furniture, and other belongings or property. To ensure stability of your umbrella, please observe proper placement, and use sufficient base weight. This catalog contains minimum recommendations for necessary weight for each style. Keep umbrella properly secured to an umbrella base at all times. Thoroughly read and follow all provided instruction manuals.

WIND DAMAGE IS NOT COVERED UNDER OUR LIMITED WARRANTY.

Irregularities in Production Process:

The possibility of "Irregularities" in the product surface may occur during the production process. However, these irregularities do not reduce the quality of the product. Treasure Garden monitors every stage of production to ensure a clean and consistent appearance on every part.

Rust:

Rust is a natural part of the aging process of all Steel or Iron based materials and is therefore NOT considered a defect. Treasure Garden Cast Iron & Steel plate bases are designed to require minimum maintenance. Bases should be kept clean.

Do not let dirt build up on the bases. Cleaning with mild soap and water, and seasonal touch-up of any scratches, chips or occasional rust seepage from crevices or hidden, un-finishable surfaces inherent in some designs is all that is required. Touch Up paint in matching frame colors are available through your retail dealer. Never leave bases standing in water. To keep your bases looking their best, you may wish to store them when not in use for an extended period of time.

Seaside and Pool Usage:

CAUTION: Do not leave umbrella in pool for extended periods of time. It is recommended to remove the umbrella from pool and immediately clean after use. Seaside and in-pool use, salt & chlorides can accumulate on the powder coat finish, leading to finish failure. Failure to do so will void the limited warranty.

International Returns:

If an item is found to be under warranty Treasure Garden shall only be responsible for ground shipping charges to the location of the product within the continental United States. Any duties, express, international or special shipping charges are at the expense of the retail dealer or consumer.

IMPORTANT RESTRICTION FOR TG PRODUCTS WARRANTY SERVICE:

Treasure Garden restricts warranty service for TG products to the country where Treasure Garden or its authorized TG retail Dealers originally sold the product.

NO RETURNS ON CUSTOM, VALANCE OR DESIGNER CANOPY STYLE UMBRELLAS.

THE SELLER DISCLAIMS ANY IMPLIED WARRANTY OF MERCHANTABILITY.



Shademaker and Jardinico® manufacture all its shade styles from the finest aluminum alloys to ensure the strength, durability, and integrity of each and every style. We pride ourselves as a totally vertical operation. This means that we manufacture and produce over 90% of the components used in our products from the raw state. We can monitor every stage of the manufacturing process and maintain a consistent level of quality.

Our goal is that each and every Shademaker and Jardinico style will exceed your expectations.

Our **Limited Warranty** is outlined below. NOTE: Wind damage is not covered under any manufacturer's warranty.

SHADEMAKER

Aquarius, Libra, Atlas, Astral, Taurus, Solaris, Polaris, Orion, Gemini

- 10 Year Limited Warranty
 - Mast, boom, head fitting, elbow, center post/side post, arms, ribs, upper and lower hub, and stainless steel hardware
- 5 Year Limited Warranty
 - Frame finishes, including powder coated
 - Lift system components, including crank mechanism
- 1 Year Limited Warranty
 - Rib lights
 - Battery Pack

Titan, Infinity, Z-Plate Bases

- 10 Year Limited Warranty
 - Galvanized frame
 - Galvanized steel plates
 - Hot zinc steel plates
- 5 Year Limited Warranty
 - Powder coat finish
 - Base lid
- 1 Year Limited Warranty
 - Base wheels

Sand Anchor

- 3 Year Limited Warranty
 - Powder coat finish
 - Stainless Steel Hitch Pin

Aspen, Athens, Aurora Bases

- 2 Year Limited Warranty
 - Cast aluminum base
- 1 Year Limited Warranty
 - Base wheels
 - Base stem
 - Powder coat finish

External Stem, Mount Kits, Steel Base, Monaco Base, Commercial Base, Add-on Weight, Protective Covers

- 1 Year Limited Warranty
 - Stem, adapter plate and in-ground fitting
 - Base wheels
 - Powder coat finish

JARDINICO

JCP.101, JCP.201, JCP.301, JCP.401, JCP.501, JCB.101, JCB.301, JCB.401

- 5 Year Limited Warranty
 - Mast, head fitting, elbow, center post/side post, arms, ribs, top and bottom hub, stainless steel hardware, and bases
 - Powder coat finish

Mount Kits, Protective Covers, Accessories

- 1 Year Limited Warranty
 - Adapter plate, in-ground fitting
 - Wheels

FABRIC

10 Year Limited Warranty applies to Sunbrella awning and marine grade fabrics collection. Visit www.sunbrella.com for more details. Labor charges are not covered under this limited warranty. NOTE: Sunbrella awning/marine fabric is treated with a finish which gives the fabric its water repellency and a firmer hand which helps in the sewing and fabrication of the products. Mark-off/Crazing may appear as white scuff marks or thin white lines on the fabric which will normally diminish or go away with normal weathering and will not affect the overall performance of the product.

5 Year Limited Warranty applies to Glen Raven FRESIST® and Sunbrella®/Outdura®/ Bliss furniture grade, and O'bravia® awning grade fabrics. For more details, visit www.sunbrella.com, www.outdura.sattler.com, www.blissfabrics.es, and www.obravia.com

What Is NOT Covered:

Failure caused by unreasonable or abusive use, or failure caused by neglect of reasonable and necessary care, and any modification to product are not covered by this warranty. We will only warranty products which are properly secured to an adequate base or mounting system and adhere to our required base weight minimums. If the powder coat finish flakes, bubbles, peels or loses color; Shademaker/Jardinico will re-finish or replace the defective base at its discretion. Normal wear and tear is not covered under this limited warranty. Labor charges are not covered under this limited warranty.

Additionally, acts of nature (including but not limited to wind, hurricanes, tornadoes, and storms) are not covered by this warranty. This warranty covers return freight of any warranted product only for the first year. This warranty gives you specific legal rights and you may have other rights which vary from state to state.

Closeout and promotional items sold by the dealer "as is" are not covered by this warranty.

Wind Damage:

Shademaker and Jardinico highly recommends that no umbrella, regardless of size or weight, ever be left unattended in the open position. In windy conditions, it is further recommended that umbrellas be closed, removed from their base, and stored or laid horizontally. This will reduce the risk of personal injury, damage to your umbrella, furniture, and other belongings or property. To ensure stability of your umbrella, please observe proper placement, and use sufficient base weight. This catalog contains minimum recommendations for necessary weight for each style. Keep umbrella properly secured to an umbrella base at all times. Thoroughly read and follow all provided instruction manuals.

WIND DAMAGE IS NOT COVERED UNDER OUR LIMITED WARRANTY.

Seaside and Pool Usage:

CAUTION: Do not leave umbrella in pool for extended periods of time. It is recommended to remove the umbrella from pool and immediately clean after use. Seaside and in-pool use, salt & chlorides can accumulate on the powder coat finish, leading to finish failure. Failure to do so will void the limited warranty.

Irregularities in Production Process:

The possibility of "Irregularities" in the product surface may occur during the production process. However, these irregularities do not reduce the quality of the product. Shademaker and Jardinico monitors every stage of production to ensure a clean and consistent appearance on every part.

Rust:

Rust is a natural part of the aging process of all steel based materials and is therefore NOT considered a defect. Steel plate bases are designed to require minimum maintenance. Bases should be kept clean. Do not let dirt build up on the bases. Never leave bases standing in water. To keep your bases looking their best, you may wish to store them when not in use for an extended period of time.

International Returns:

If an item is found to be under warranty Shademaker and Jardinico shall only be responsible for ground shipping charges to the location of the product within the continental United States and Canada. Any duties, express, international or special shipping charges are at the expense of the retail dealer or consumer.

Important Restriction for Shademaker and Jardinico products Warranty Service:

Shademaker and Jardinico restricts warranty service products to the country where Shademaker, Jardinico or its authorized retail dealers originally sold the product.

It is our policy to continuously improve designs, materials and manufacturing methods in order to provide you with the finest products. Therefore, variations in specifications, materials, prices, styles and finishes may be made without notice.

NO RETURNS ON CUSTOM, VALANCE OR DESIGNER CANOPY STYLE UMBRELLAS.

THE SELLER DISCLAIMS ANY IMPLIED WARRANTY OF MERCHANTABILITY.

Those filing warranty claims will be responsible for all shipping, handling, and freight charges on all claims to Shademaker/Jardinico in Baldwin Park, CA. All warranty claims must be submitted with the original proof of purchase, date of purchase, name of dealer, and the description of the damage. The Shademaker and Jardinico warranty is not transferable. Shademaker and Jardinico reserves the right to repair, replace, and/or redesign any product that is returned under a warranty claim.

For questions, contact Shademaker/Jardinico Customer Service:
626-338-8810, info@shademakerusa.com or info@jardinicousa.com



SHOWN

Umbrella:
UM810-SS

7863 New Block Smoke Stripe

Base:
BG502

